



Product Name: PV Grid-Connected Inverter
Company Name: Shenzhen SOFARSOLAR Co., Ltd.
ADD: 401, Building 4, AnTongDa Industrial Park, District 68, XingDong Community,
XinAn Street, BaoAn District, Shenzhen, Guangdong.P.R. China
Email: service@sofarsolar.com
Tel: 0510-6690 2300
Web: www.sofarsolar.com



User manual

Solar Grid-tied Inverter

Product Model: SOFAR I.IK-3.3KTL-G3 (2019.08.20)



Shenzhen SOFARSOLAR CO., Ltd.

Notice

This manual contains important safety instructions that must be followed during installation and maintenance of the equipment.

Save these instructions!

This manual must be considered as an integral part of the equipment, and must be available at all times to everyone who interacts with the equipment. The manual must always accompany the equipment, even when it is transferred to another user or field.

Copyright Declaration

The copyright of this manual belongs to Shenzhen SOFARSOLAR Co., Ltd. Any corporation or individual should not plagiarize, partially copy or fully copy it (including software, etc.), and no reproduction or distribution of it in any form or by any means. All rights reserved. SOLARSOFAR reserves the right of final interpretation. This manual is subject to change according to user's or customer's feedback. Please check our website at <http://www.sofarsolar.com> for latest version.

Shenzhen SOFARSOLAR Co., Ltd.

ADD:401, Building 4, AnTongDa Industrial Park, District 68,XingDong
Community, XinAn Street, BaoAn District, Shenzhen, GuangDong.P.R. China
[Http://www.sofarsolar.com](http://www.sofarsolar.com)

P. C. : 518000

E-mail: service@sofarsolar.com

Preface

Outline

Please read the product manual carefully before installation, operation or maintenance. This manual contains important safety instructions and installation instructions that must be followed during installation and maintenance of the equipment.

• Scope

This product manual describes the installation, electrical connections, commissioning, maintenance and troubleshooting of SOFAR 1.1K~3.3KTL-G3 inverters:

1100TL-G3, 1600TL-G3, 2200TL-G3, 2700TL-G3, 3000TL-G3, 3300TL-G3

Keep this manual where it will be accessible at all times.

• Target Group

This manual is intended for qualified electrical technical personnel who are responsible for inverter installation and commissioning in the PV power system and the PV plant operator.

• Symbols Used

This manual provides safety operation information and uses the symbol in order to ensure personal and property security and use the inverter efficiently when operating the inverter. You must understand these emphasized information to avoid the personal injury and property loss. Please read the following symbols used in this manual carefully.







 Danger	Danger indicates a hazardous situation which, if not avoided, will result in death or serious injury.
 Warning	Warning indicates a hazardous situation which, if not avoided, could result in death or serious injury.
 Caution	Caution indicates a hazardous situation which, if not avoided, could result in minor or moderate injury.
 Attention	Attention indicated potential risks which, if not avoided, may lead to equipment fault or property damage.
 Note	Note provides tips that are valuable for the optimal operation of the product.

Table of contents

Preface	II
1 Basic safety information	1
1.1 Safety instructions	1
1.2 Symbols and signs	3
2 Product characteristics	5
2.1 Product identification	5
2.2 Function description	7
2.3 Efficiency curve	8
3 Installation	9
3.1 Installation Process	9
3.2 Checking Before Installation	9
3.3 Tools	11
3.4 Determining the Installation Position	12
3.5 Moving the SOFAR 1.1K~3.3KTL-G3 inverter	14
3.6 Installing SOFAR 1.1K~3.3KTL-G3 inverter	15
4 Electrical Connections	16
4.1 Electrical connection	17
4.2 Connecting PGND Cables	17
4.3 Connecting DC Input Power Cables	18
4.4 Connecting AC Output Power Cables	20
4.5 RS485, CT, and Inverter logic interface connection	23
4.6 WIFI/GPRS module installation procedure	28
4.7 Communication method	29
5 Commissioning of inverter	31
5.1 Safety inspection before commissioning	31
5.2 Start inverter	31

6 Operation interface	32
6.1 Operation and Display Panel	32
6.2 Standard Interface	33
6.3 Main Interface	35
6.4 Update Software online	44
7 Trouble shooting and maintenance	47
7.1 Trouble shooting	47
7.2 Maintenance	51
8 Technical data	52
8.1 Input parameter (DC)	52
8.2 Output parameter (AC)	52
8.3 Efficiency, Safety and Protection	53
8.4 General Data	53
9 Quality Assurance	54

1 Basic safety information

	<p>If you have any question or problem when you read the following information, please contact Shenzhen SOFARSOLAR Co., Ltd .</p>
Note	

Outlines of this chapter

Safety instruction

It mainly introduce the safety instruction when install and operate the equipment.

Symbols and signs

It mainly introduce the safety symbols on the inverter.

1.1 Safety instructions

- Read and understand the instructions of this manual, and be familiar with relevant safety symbols in this chapter, then start to install and troubleshoot the equipment.
- According to the national and state requirements, before connecting to the electrical grid, you must get permission from the local electrical grid operator, and the operation can only be performed by qualified electrical engineer.
- Please contact the nearest authorized service center if any maintenance or repair is needed. Contact your distributor for the information of the nearest authorized service center. Do NOT repair it by yourself, it may cause injury or property damage.
- Before installing and maintaining the equipment, you should turn the DC switch OFF to cut off the high voltage DC of the PV array. You can also turn the switch in the PV combiner box OFF to cut off the high voltage DC. Otherwise, serious injury may be caused.

Qualified persons

The customer must make sure the operator has the necessary skill and training to do his/her job. Staff in charge of using and maintaining the equipment must be skilled, aware and mature for the described tasks and must have the reliability to correctly interpret what is described in the manual. For safety reason only a qualified electrician, who has received training and / or has demonstrated skills and knowledge in construction and in operation of this unit, can install this inverter. Shenzhen SOFARSOLAR Co., Ltd does not take any responsibility for the property destruction and personal injury because of any incorrect use.

Installation requirements

Please install inverter according to the following section. Fix the inverter on an appropriate objects with enough load bearing capacity (such as walls, PV racks etc.), and ensure that inverter is vertical placed. Choose a place suitable for installing electrical devices. And assure there is enough fire exit space, convenient for maintenance. Maintain proper ventilation to ensure enough air cycle to cool the inverter.

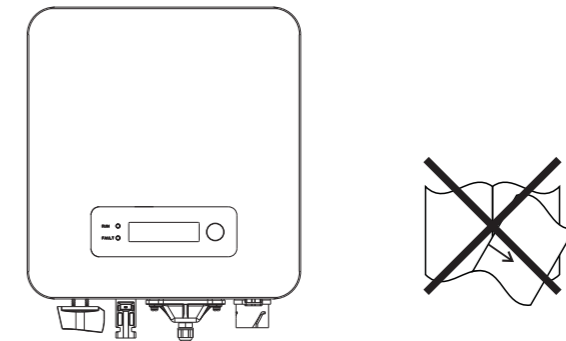





Transport requirements



If you find packing problems that may cause the damage of the inverter, or find any visible damage, please immediately notice the responsible transportation company. You can ask solar equipment installation contractor or Shenzhen SOFARSOLAR Co.Ltd for help if necessary. Transport of the equipment, especially by road, must be carried out with by suitable ways and means for protecting the components (in particular, the electronic components) from violent shocks, humidity, vibration, etc.

Electric connection



Please comply with all the current electrical regulations about accident prevention in dealing with the solar inverter.

 Danger	<p>Before the electrical connection, make sure to use opaque material to cover the PV modules or to disconnect PV array DC switch. Exposure to the sun, PV array will produce a dangerous voltage!</p>
 Warning	<p>All installation accomplished only by professional electrical engineer!</p> <ul style="list-style-type: none"> • must be trained; • Completely read the manual operation and understand relevant matters.
 Attention	<p>Get permission from the local electrical grid operator, complete all electrical connections by professional electrical engineer, then connect inverter to electrical grid.</p>
 Note	<p>It's forbidden to remove the tamper evident label, or open the inverter. Otherwise Sofarsolar will not provide warranty or maintenance!</p>

Operation

	<p>Touching the electrical grid or the terminal of the equipment may lead to electrocution or fire!</p> <ul style="list-style-type: none"> • Don't touch the terminal or conductor connected to the electrical grid. • Pay attention to any instructions or safety documents related to grid connection.
Danger	
	<p>Some internal components will be very hot when inverter is working. Please wear protective gloves!</p>
Attention	

Maintenance and repair

	<ul style="list-style-type: none"> • Before any repair work, turn OFF the AC circuit breaker between the inverter and electrical grid first, then turn OFF the DC switch. • After turning OFF the AC circuit breaker and DC switch, wait for 5 minutes at least before carrying out any maintenance or repair work.
Danger	
	<ul style="list-style-type: none"> • Inverter should work again after removing any faults. If you need any repair work, please contact with the local authorized service center; • Can't open the internal components of inverter without authorized. Shenzhen SOFARSOLAR Co., Ltd. does not take any responsibility for the losses from that.
Attention	

EMC / noise level of inverter

Electromagnetic compatibility (EMC) refers to that one electrical equipment functions in a given electromagnetic environment without any trouble or error, and impose no unacceptable effect upon the environment. Therefore, EMC represents the quality characters of an electrical equipment.



- The inherent noise-immune character: immunity to internal electrical noise.
- External noise immunity: immunity to electromagnetic noise of external system.
- Noise emission level: influence of electromagnetic emission upon environment.

	<p>Electromagnetic radiation from inverter may be harmful to health!</p> <ul style="list-style-type: none"> • Please do not continue to stay around the inverter in less than 20 cm when inverter is working.
Danger	

1.2 Symbols and signs







Safety symbols

	<p>Caution of burn injuries due to hot enclosure!</p> <ul style="list-style-type: none"> • You can only touch the screen and pressing key of the inverter while it's working.
Caution	

	<p>PV array should be grounded in accordance to the requirements of the local electrical grid operator!</p> <ul style="list-style-type: none"> • We suggest that all PV module frames and inverter are reliably grounded to protect the PV system and personnel security.
Attention	
	<p>Ensure input DC voltage < Max. DC voltage .Over voltage may cause permanent damage to inverter or other losses, which will not be included in warranty!</p>
Warning	

Signs on the inverter

There are some symbols which are related to security on the inverter. Please read and understand the content of the symbols, and then start the installation.

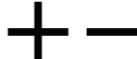
	There is a residual voltage in the inverter! Before opening the equipment, operator should wait for five minutes to ensure the capacitor is discharged completely.
	Caution, risk of electric shock.
	Caution, hot surface.
	Comply with the Conformite Europeenne (CE) certification.
	Grounding point.
	Please read this manul before install SOFAR 1.1K~3.3KTL-G3.
	This indicates the degree of protection of the equipment according to IEC standard 70-1 (EN 60529 June 1997).
	Positive pole and negative pole of the input voltage (DC).

2 Product characteristics

Outlines of this chapter

Product dimensions

It introduces the field of use, and the overall dimensions of SOFAR 1.1K~3.3KTL-G3 inverters.

Function description

It introduces how SOFAR 1.1K~3.3KTL-G3 inverters work and the function modules inside.

Efficiency curves

It introduces the efficiency curves of in the inverter.

2.1 Product dimensions

Field of use

SOFAR 1.1K~3.3KTL-G3 is a single MPPT grid-tied PV inverter which converts the DC power generated by PV arrays into sine wave single-phase AC power and feeds it to the public electrical grid, AC circuit breaker (refer to Section 4.4) and DC switch used as disconnect device, and the disconnect device shall be easily accessible.

Figure2-1 PV Grid-tied System

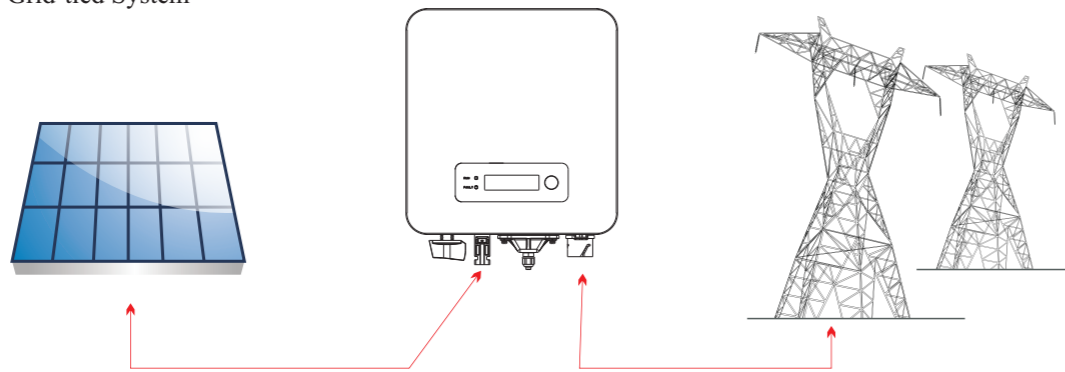

SOFAR 1.1K~3.3KTL-G3 inverters can only be used with photovoltaic modules that do not require one of the poles to be grounded. The operating current during normal operation must not exceed the limits specified in the technical specifications. Only the photovoltaic modules can be connected to the input of the inverter (do not connect batteries or other sources of power supply).

- The choice of optional parts of inverter should be made by a qualified technician who knows the installation conditions clearly.
- SOFAR 1100TL-G3 SOFAR 1600TL-G3 SOFAR 2200TL-G3:L×W×H=303mm×260.5mm×118mm
SOFAR 2700TL-G3 SOFAR 3000TL-G3 SOFAR 3300TL-G3:L×W×H=321mm×260.5mm×131.5mm

Figure 2-2 Front view and left view dimensions of SOFAR 1100TL-G3, SOFAR 1600TL-G3 and SOFAR 2200TL-G3

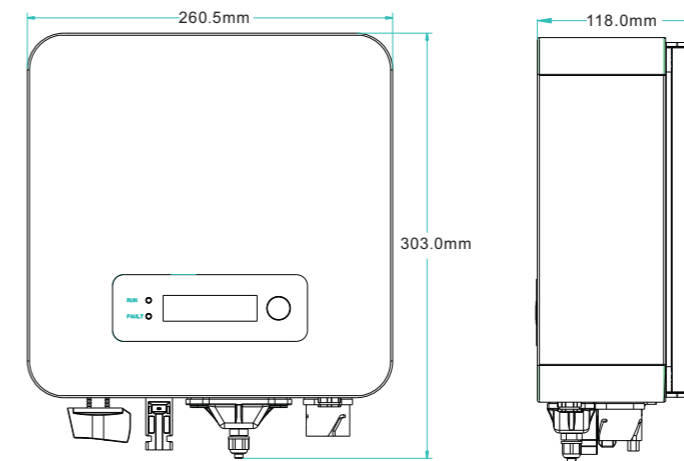

Figure 2-3 Front view and left view dimensions of SOFAR 2700TL-G3, SOFAR 3000TL-G3 and SOFAR 3300TL-G3

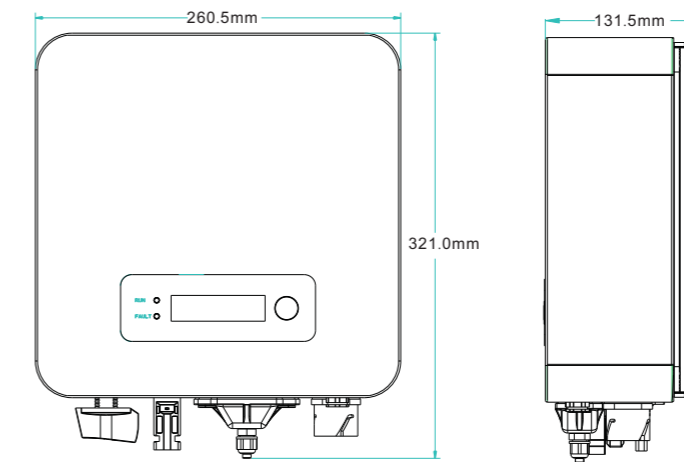
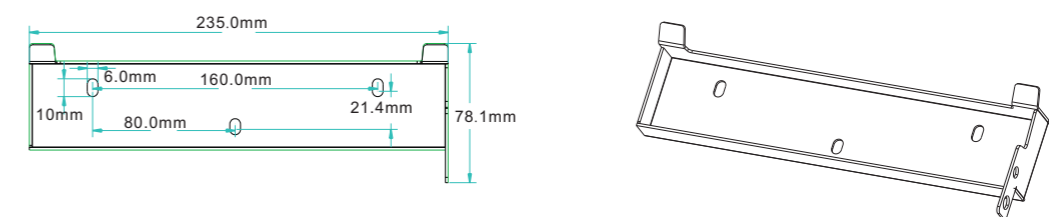

Figure 2-4 Bracket dimensions of SOFAR 1.1K~3.3KTL-G3



• Labels on the equipment :



The labels must NOT be hidden with objects and extraneous parts (rags, boxes, equipment, etc.); they must be cleaned regularly and kept visible at all times.

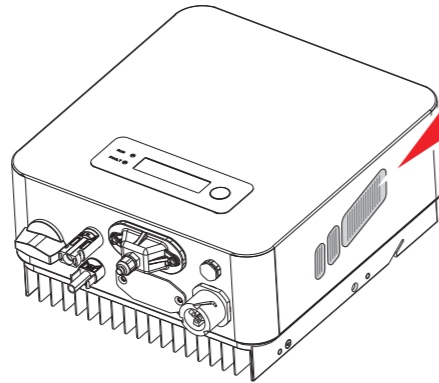

SOFAR Solar Grid-tied Inverter	
Model No.	SOFAR 3300TL-G3
Max DC Input Voltage	550V
Operating MPPT Voltage Range	50~550V
Max. Input Current	12A
Max. PV Isc	15A
Nominal Grid Voltage	L/N/PE, 230Vac
Max. Output Current	16A
Nominal Grid Frequency	50/60Hz
Max. Output Power	3300VA
Power Factor	1(adjustable+/-0.8)
Ingress protection	IP65
Operating Temperature Range	-30~+60°C
Protective Class	Class I
Manufacturer: Shenzhen SOFARSOLAR Co., Ltd. Address: 401, Building 4, AnTongDa Industrial Park, District 66, XingDong Community, XinAn Street, BaoAn District, Shenzhen, China	
VDE0126-1-1, VDE-AR-N4105, IEC61727, IEC62116, ULTE C15-712-1, A84777	

2.2 Function description

DC power generated by PV array is filtered through Input Board before entering into Power Board. Input Board also offer functions such as insulation impedance detection and input DC voltage / current detection. DC power is converted to AC power by Power Board. AC power is filtered through Output Board then AC power is fed into the grid. Output Board also offer functions such as grid voltage / output current detection, GFCI and output isolation relay. Control Board provides the auxiliary power, controls the operation state of inverter and shows the operation status by Display Board. Display Board displays fault code when inverter is in abnormal operation conditions. At the same time, Control Board can trigger the relay so as to protect the internal components.

• Function module

A. Energy management unit

This control can be used to switch the inverter on/off through an external (remote) control.

B. Feeding reactive power into the grid

The inverter is able to produce reactive power and can therefore feed it into the grid through the setting of the phase shift factor. Feed-in management can be controlled directly by the grid company through a dedicated RS485 serial interface.

C. Limiting the active power fed into the grid

The inverter, if enabled can limit the amount of active power fed into the grid by the inverter to the desired value (Expressed as a percentage).

D. Self power reduction when grid is over frequency

When the grid frequency is higher than the limited value, inverter will reduce output power which is necessary for the grid stability.

E. Data transmission

The inverter or a group of inverters may be monitored remotely through an advanced communication system based on RS-485 serial interface, or remotely via the WIFI.

F. Software update

SD card is used for updating the firmware.

• Electrical block diagram

Figure2-5 Electrical block diagram

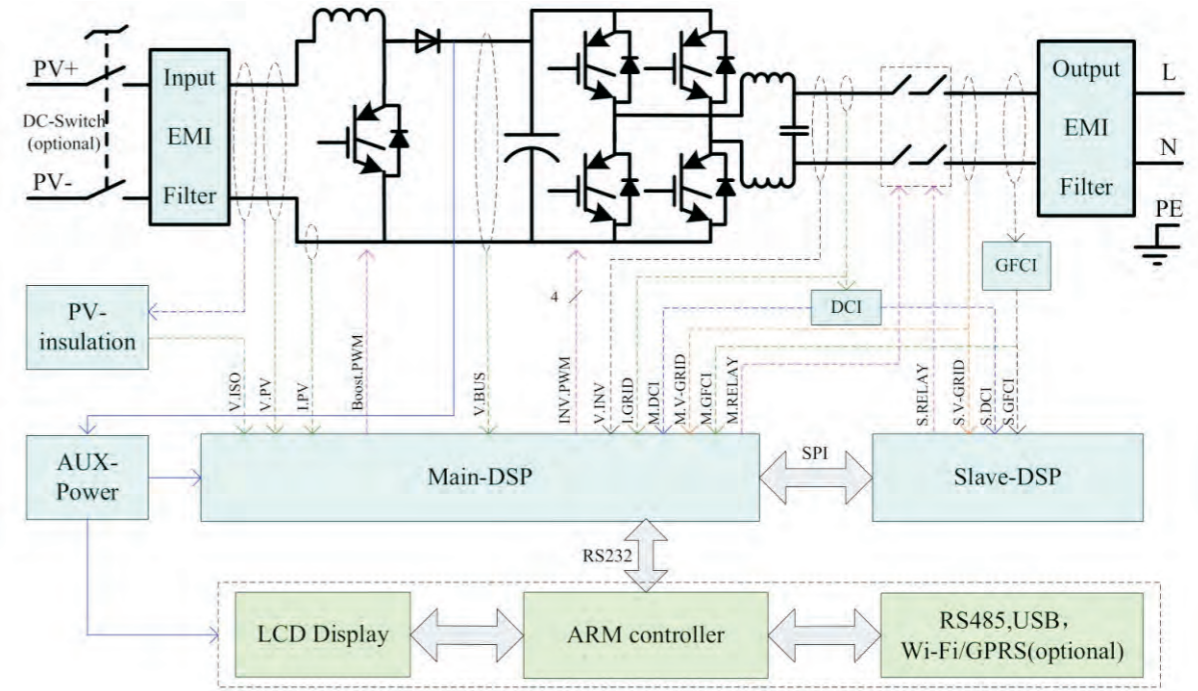

2.3 Efficiency curve

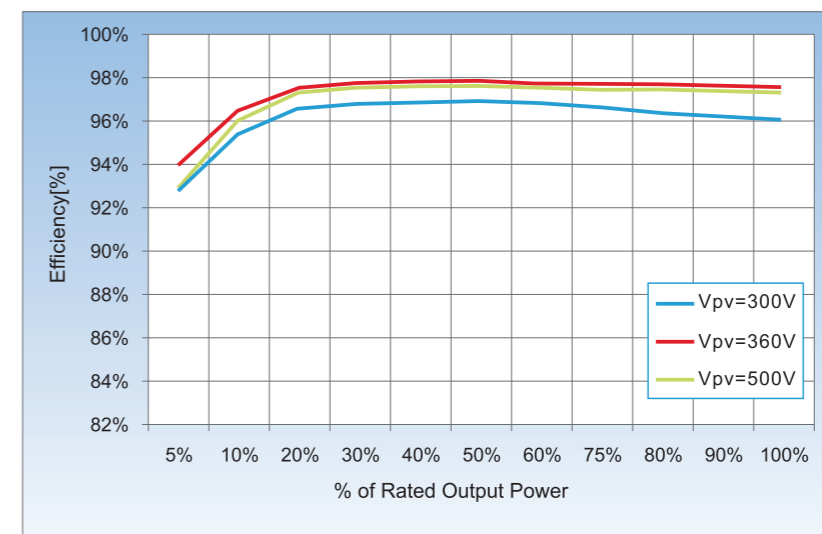



3 Installation

Outlines of this chapter

This topic describes how to install the SOFAR 1.1K~3.3KTL-G3 inverter.

Installation notes

 Danger	<ul style="list-style-type: none"> Do NOT install the SOFAR 1.1K~3.3KTL-G3 on flammable material. Do NOT install the SOFAR 1.1K~3.3KTL-G3 in an area used to store flammable or explosive materials.
 Caution	The enclosure and heat sink are very hot while the inverter is working, therefore do NOT install the SOFAR 1.1K~3.3KTL-G3 in places where you might touch them inadvertently.
 Attention	<ul style="list-style-type: none"> Consider the weight of SOFAR 1.1K~3.3KTL-G3 when transporting and moving the inverters. Choose an appropriate mounting position and surface. Assign at least two persons to install the inverter.

3.1 Installation Process

Figure3-1 Installation flowchart

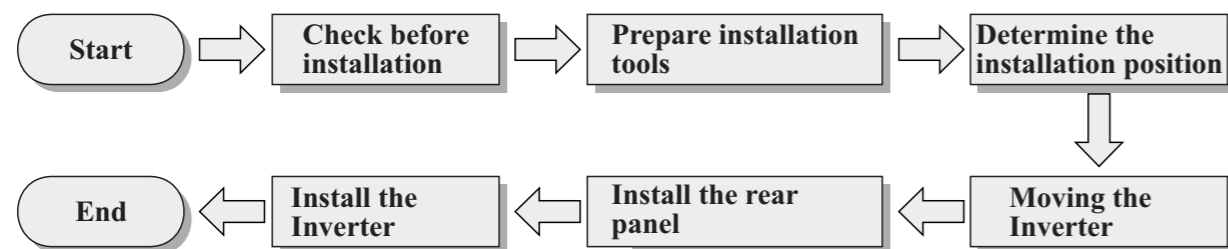

3.2 Checking Before Installation







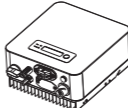
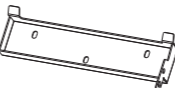
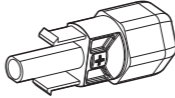
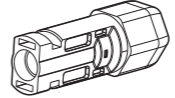

Checking Outer Packing Materials

Packing materials and components may be damaged during transportation. Therefore, check the outer packing materials before installing the inverter. Check the outer packing materials for damage, such as holes and cracks. If any damage is found, do not unpack the SOFAR 1.1K~3.3KTL-G3 and contact the dealer as soon as possible. You are advised to remove the packing materials within 24 hours before installing the SOFAR 1.1K~3.3KTL-G3 inverter.

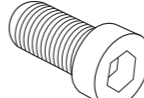
Checking Deliverables

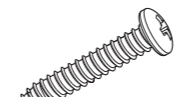
After unpacking the inverter, check whether deliverables are intact and complete. If any damage is found or any component is missing, contact the dealer.

Table3-1 shows the components and mechanical parts that should be delivered



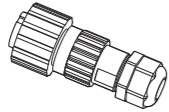

No.	Pictures	Description	Quantity
1		SOFAR 1.1K~3.3KTL-G3	1 pcs
2		Rear panel	1 pcs
3		PV+ input terminal	1 pcs
4		PV-input terminal	1 pcs
5		Metal terminals secured to PV+ input power cables	1 pcs
6		Metal terminals secured to PV- input power cables	1 pcs
7		M5 Hexagon screws	2 pcs
8		Expansion bolts	3 pcs
9		Self-tapping screw	5 pcs
10		Manual	1 pcs
11		The warranty card	1 pcs
12		Registration Form	1 pcs

No.	Pictures	Description	Quantity
13		AC output terminal	1PCS

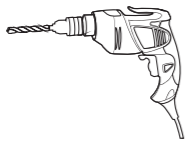
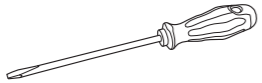
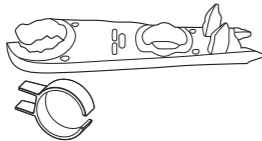
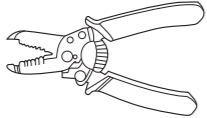
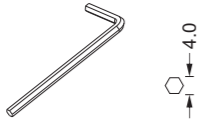
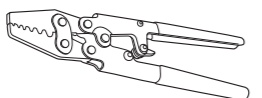
3.3 Tools

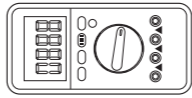
Prepare tools required for installation and electrical connections.
Table 3-2 shows the tools required for installation and electrical connections.

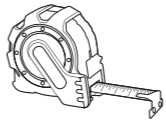
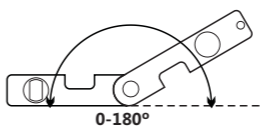
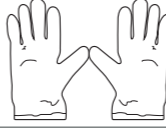
No.	Tool	Model	Function
1		Hammer drill Recommend drill dia. 6mm	Used to drill holes on the wall
2		Screwdriver	wiring
3		Removal tool	Remove PV terminal
4		Wire stripper	Strip wire
5		4mm Allen Wrench	Turn the screw to connect rear panel with inverter
6		Crimping tools	Used to crimp power cables

No.	Tool	Model	Function
7		Multi-meter	Used to check grounding
8		Marker	Used to mark signs
9		Measuring tape	Used to measure distances
10		Level	Used to ensure that the rear panel is properly installed
11		ESD gloves	Operators wear
12		Safety goggles	Operators wear
13		Anti-dust respirator	Operators wear

3.4 Determining the Installation Position

Determine an appropriate position for installing the SOFAR 1.1K~3.3KTL-G3 inverter.
Comply with the following requirements when determining the installation position:

Figure3-2 Installation Requirements

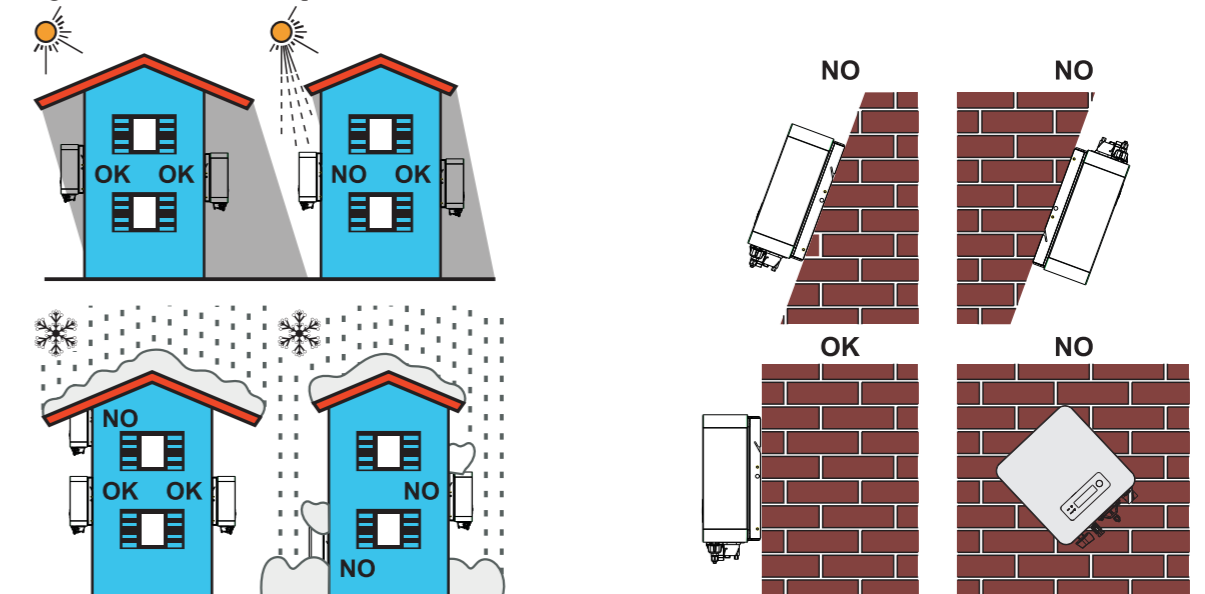

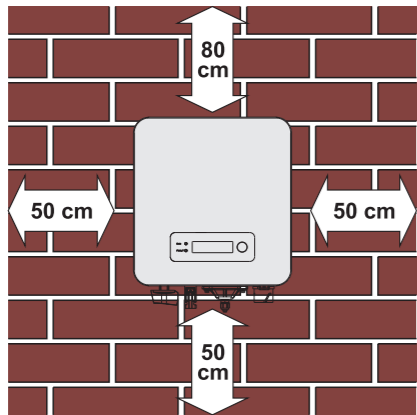
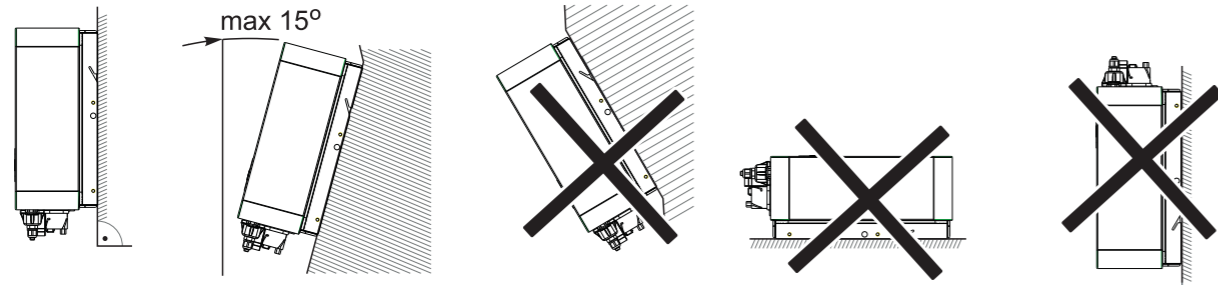

clearance for single SOFAR 1.1K~3.3KTL-G3 inverter

Installation of multiple SOFAR 1.1K~3.3KTL-G3 inverters

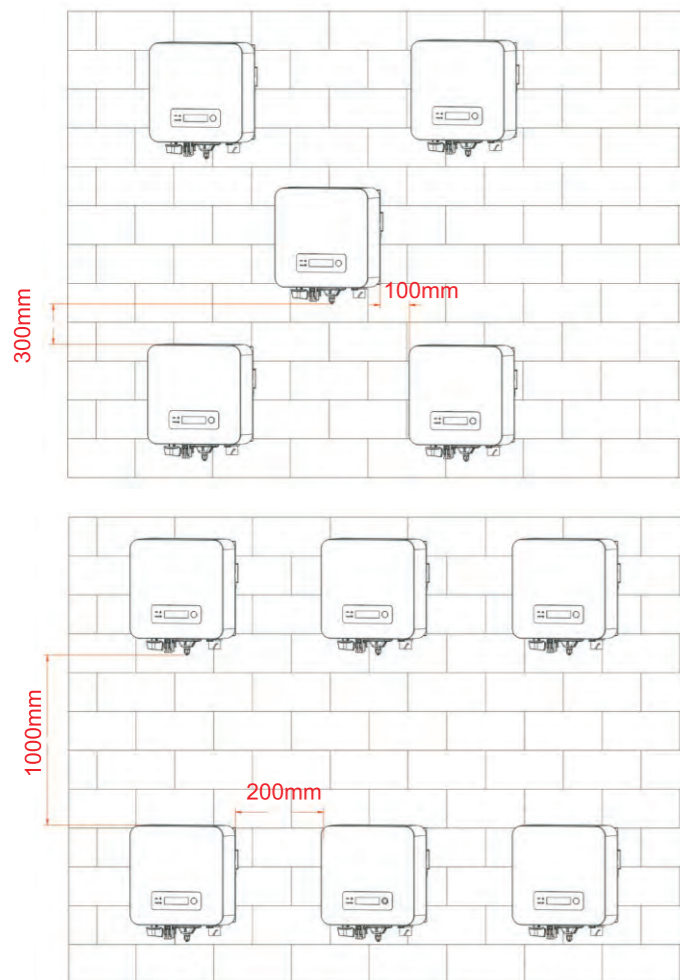

3.5 Moving the SOFAR 1.1K~3.3KTL-G3 inverter

This topic describes how to move the SOFAR 1.1K~3.3KTL-G3 to the installation position horizontally

Step 1 Open the packaging, insert hands into the slots on both sides of the inverter and hold the handles, as shown in Figure 3-3 and Figure 3-4.

Figure 3-3 Moving the inverter (1)

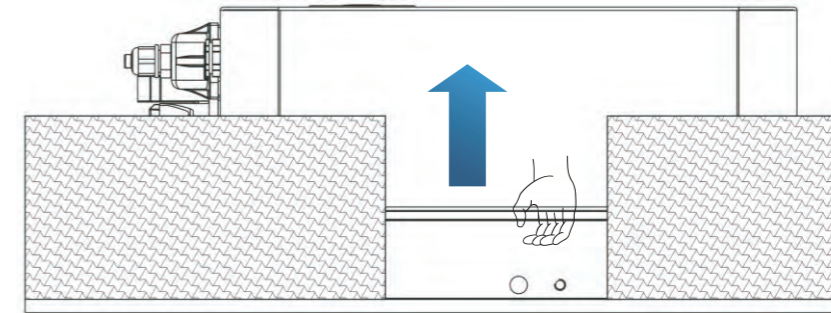
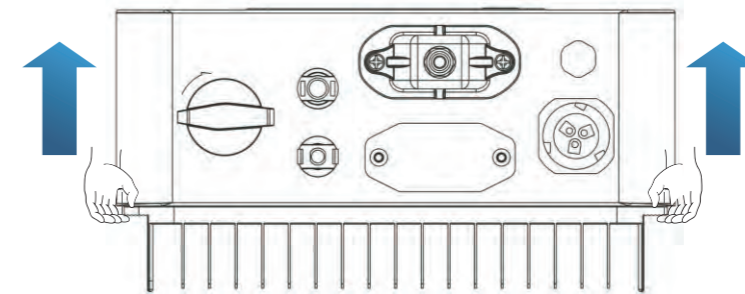

Figure 3-4 Moving the inverter (2)



Step 2 Lift the SOFAR 1.1K~3.3KTL-G3 from the packing case and move it to the installation position.

	<ul style="list-style-type: none"> To prevent device damage and personal injury, keep balance when moving the inverter because the inverter is heavy. Do not put the inverter with its wiring terminals contacting the floor because the power ports and signal ports are not designed to support the weight of the inverter. Place the inverter horizontally. When placing the inverter on the floor, put foam or paper under the inverter to protect its shell.
Attention	

--- End

3.6 Installing SOFAR 1.1K~3.3KTL-G3 inverter

Step 1 Determine the positions for drilling holes, ensure the hole positions are level, then mark the hole positions using a marker pen, use the hammer drill to drill holes on the wall. Keep the hammer drill perpendicular to the wall, do not shake when drilling, so as not to damage the wall. If the error of the hole positions is too big, you need to reposition.

Step 2 Insert the expansion bolt vertically into the hole, pay attention to the insertion depth of the expanding bolt (should be deep enough).

Step 3 Align the rear panel with hole positions, fix the rear panel on the wall by tightening the expansion bolt with the nuts.

Figure 3-5

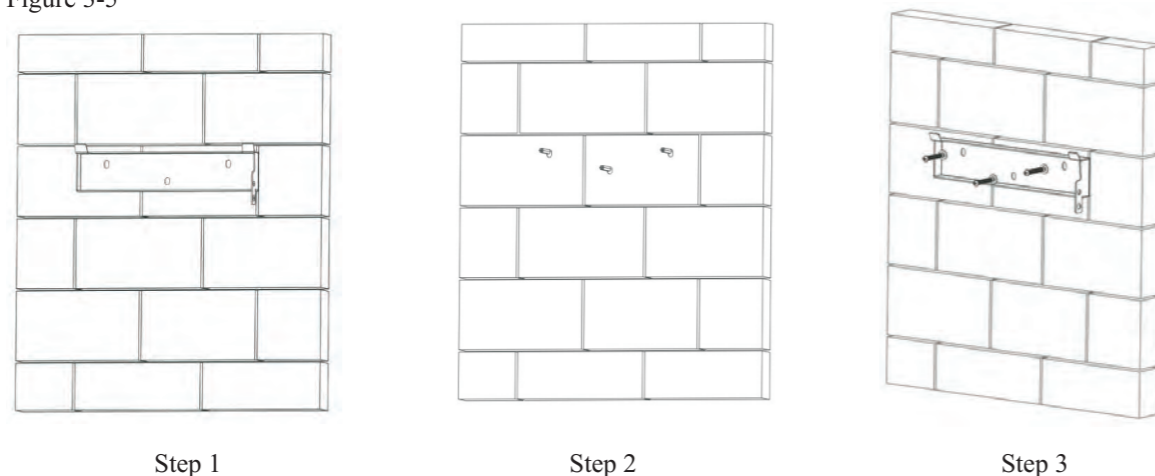

Step 4 Hook the inverter to the rear panel. Using an M5 screw to secure the inverter to the rear panel to ensure safety.

Step 5 You can secure the inverter to the rear panel and protect it from stealing by installing an anti-theft lock (this action is optional).

Figure 3-6

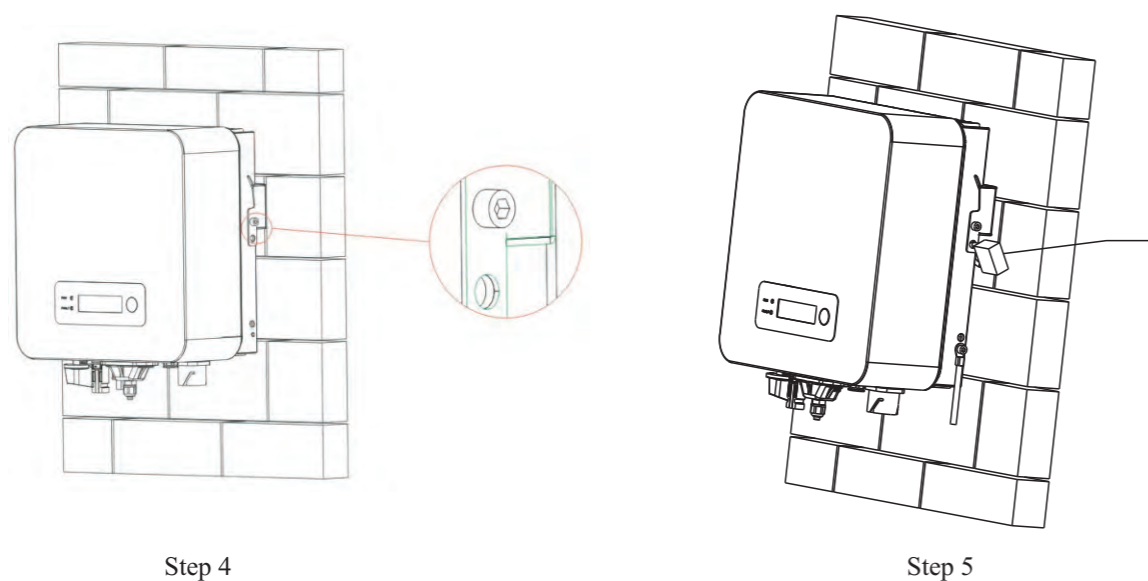

4 Electrical Connections

Outlines of this chapter

This topic describes the SOFAR 1.1K~3.3KTL-G3 inverter electrical connections. Read this part carefully before connecting cables.

NOTE: Before performing electrical connections, ensure that the DC switch is OFF. Since the stored electrical charge remains in a capacitor after the DC switch is turned OFF. So it's necessary to wait for at least 5 minutes for the capacitor to be electrically discharged.

	Installation and maintenance of inverter, must be operated by professional electrical engineer.
Attention	
	PV modules generate electric energy when exposed to sunlight and can create an electrical shock hazard. Therefore, before connecting DC input power cable, cover PV modules using opaque cloth.
Danger	
	<ul style="list-style-type: none"> For SOFAR 1.1K~2.2KTL-G3, open-circuit voltage (Voc) of module arrays connected in series must be $\leq 500V$; For SOFAR 2.2K~3.3KTL-G3, it must be $\leq 550V$. The power of PV grid-tied system which contain by several the SOFAR 1.1K~3.3KTL-G3 inverters must be $< 3.68kw$ in Germany.
Note	

The connected PV modules must have an IEC 61730 Class A rating.

Isc PV _a (absolute maximum)	15A	
Maximum output overcurrent protection	SOFAR 1100TL-G3	5.3A
	SOFAR 1600TL-G3	7.7A
	SOFAR 2200TL-G3	10.6A
	SOFAR 2700TL-G3	13A
	SOFAR 3000TL-G3	14.3A
	SOFAR 3300TL-G3	16A

The decisive voltage class(DVC).

NOTE:

The DVC is the voltage of a circuit which occurs continuously between any two live part in the worst-case rated operating condition when used as intended.

Interface	DVC
PV input interface	DVC C
AC output interface	DVC C
RS485 interface	DVC A
USB interface	DVC A
WiFi/GPRS/Ethernet interface	DVC A

4.1 Electrical connection

Figure4-1 Shows the flowchart for connecting cables to the inverter

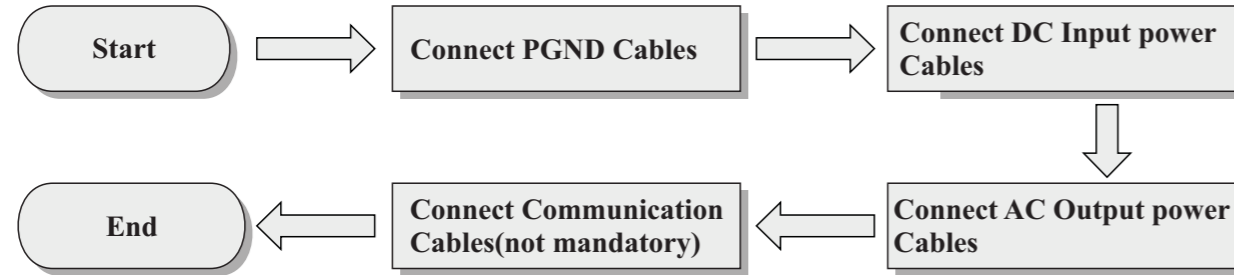

4.2 Connecting PGND Cables

Connect the inverter to the grounding electrode using protection ground (PGND) cables for grounding purposes.

Attention

The inverter is transformer-less, requires the positive pole and negative pole of the PV array are NOT grounded. Otherwise it will cause inverter failure. In the PV power system, all non current carrying metal parts (such as: PV module frame, PV rack, combiner box enclosure, inverter enclosure) should be connected to earth.

Prerequisites:

The PGND cables are prepared ($\geq 4\text{mm}^2$ outdoor power cables are recommended for grounding purposes),the color of cable should be yellow-green.

Procedure:

Step 1 Remove the insulation layer with an appropriate length using a wire stripper, as shown in Figure 4-2.

Figure4-2 Preparing a ground cable (1)

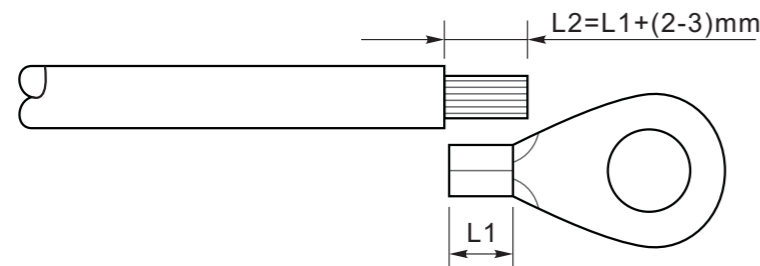

Note : L2 is 2 to 3mm longer than L1

Step 2 Insert the exposed core wires into the OT terminal and crimp them by using a crimping tool, as shown in Figure 4-3.

Figure4-3 Preparing a ground cable (2)

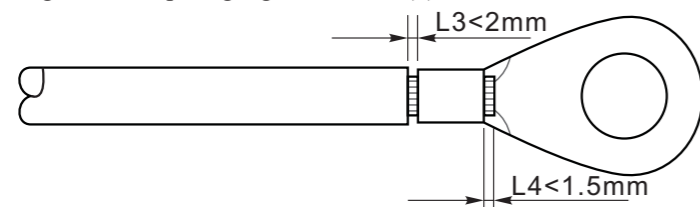

Note 1: L3 is the length between the insulation layer of the ground cable and the crimped part.L4 is the distance between the crimped part and core wires protruding from the crimped part.

Note 2: The cavity formed after crimping the conductor crimp strip shall wrap the core wires completely. The core wires shall contact the terminal closely.

Step 3 Install the crimped OT terminal, flat washer using M5 screw, and tighten the screw to a torque of 3 N.m using an Allen wrench.

Figure4-4 Ground terminal composition

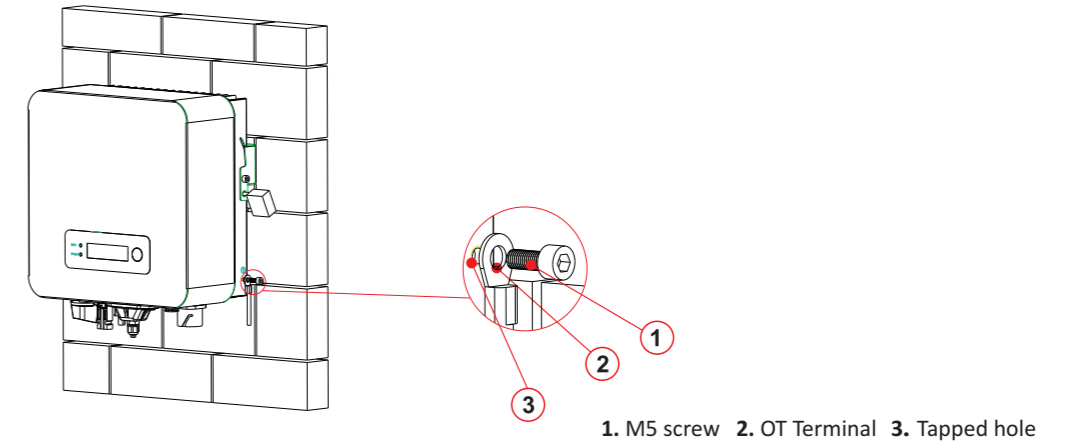

4.3 Connecting DC Input Power Cables

Table 4-1 Recommended DC input cable specifications

Cross-Sectional Area (mm ²)		External Cable Diameter(mm)
Range	Recommended Value	
4.0~6.0	4.0	4.5~7.8

Procedure

Step 1 Remove cable glands from the positive and negative connectors.

Step 2 Remove the insulation layer with an appropriate length from the positive and negative power cables by using a wire stripper as show in Figure 4-5.

Figure 4-5 Connecting DC input power cables

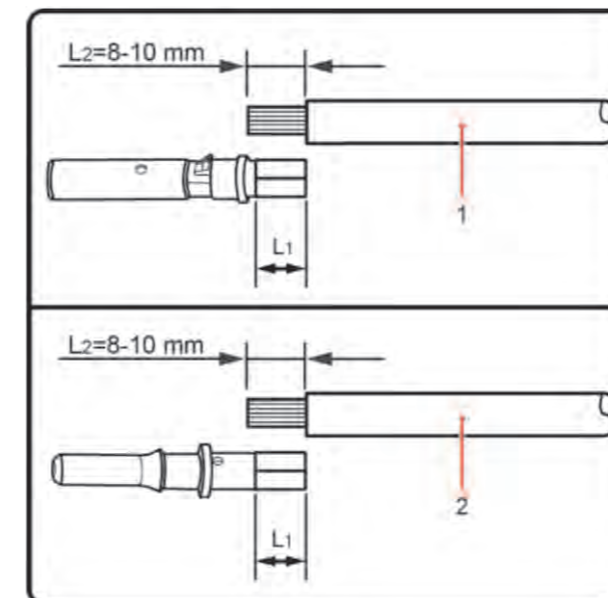

1. Positive power cable 2. Negative power cable



Note

L2 is 2 to 3 mm longer than L1.

Step 3 Insert the positive and negative power cables into corresponding cable glands.

Step 4 Insert the stripped positive and negative power cables into the positive and negative metal terminals respectively and crimp them using a clamping tool. Ensure that the cables are crimped until they cannot be pulled out by force less than 400 N, as shown in Figure 4-6.

Figure 4-6 Connecting DC input power cables

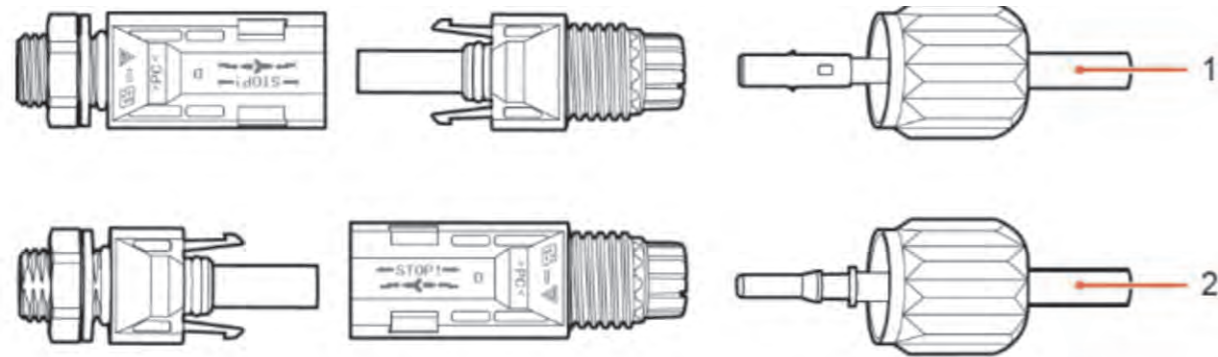

1. Positive power cable 2. Negative power cable

Step 5 Insert crimped power cables into corresponding housings until you hear a "click" sound. The power cables snap into place.

Step 6 Reinstall cable glands on positive and negative connectors and rotate them against the insulation covers.

Step 7 Insert the positive and negative connectors into corresponding DC input terminals of the inverter until you hear a "click" sound, as shown in Figure 4-7.

Figure 4-7 Connecting DC input power cables

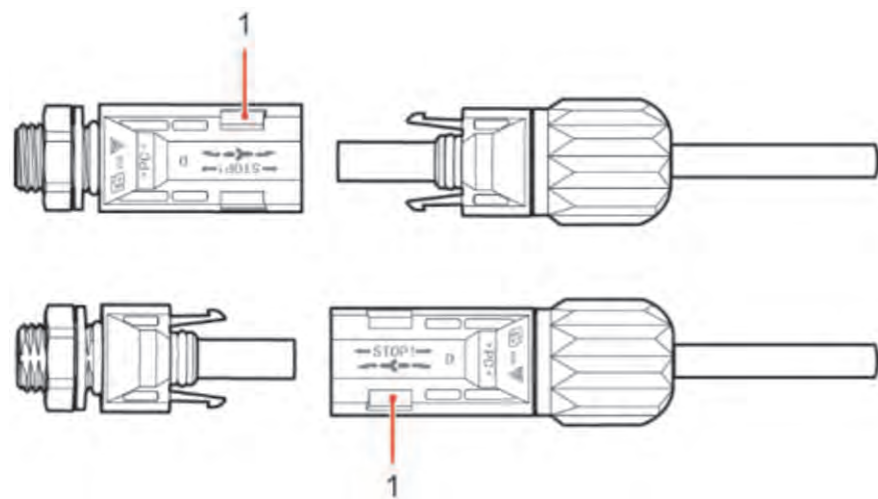

1. Bayonet



Note:

Insert the stoppers into the unused DC connectors.

--- End

Follow-up Procedure

To remove the positive and negative connectors from the inverter, insert a removal wrench into the bayonet and press the wrench with an appropriate strength, as shown in Figure 4-8.

 Caution	<p>Before removing the positive and negative connectors, ensure that the DC SWITCH is OFF.</p>
--------------------	--

Figure 4-8 Removing a DC input connector

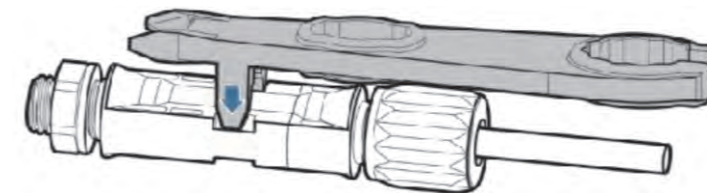

4.4 Connecting AC Output Power Cables

Connect the SOFAR 1.1K~3.3KTL-G3 to the AC power distribution frame (PDF) or power grid using AC output power cables.

 Caution	<ul style="list-style-type: none"> • It is not allowed for several inverters to use the same circuit breaker. • It is not allowed to connect loads between inverter and circuit breaker. • AC breaker used as disconnect device, and the disconnect device shall remain readily operable.
--------------------	--

Context

All the AC output cables used for the inverters are outdoor three-core cables. To facilitate the installation, use flexible cables. Table 4-2 lists the recommended specifications for the cables.

Figure 4-9 NOT allowed: connect loads between inverter and circuit breaker

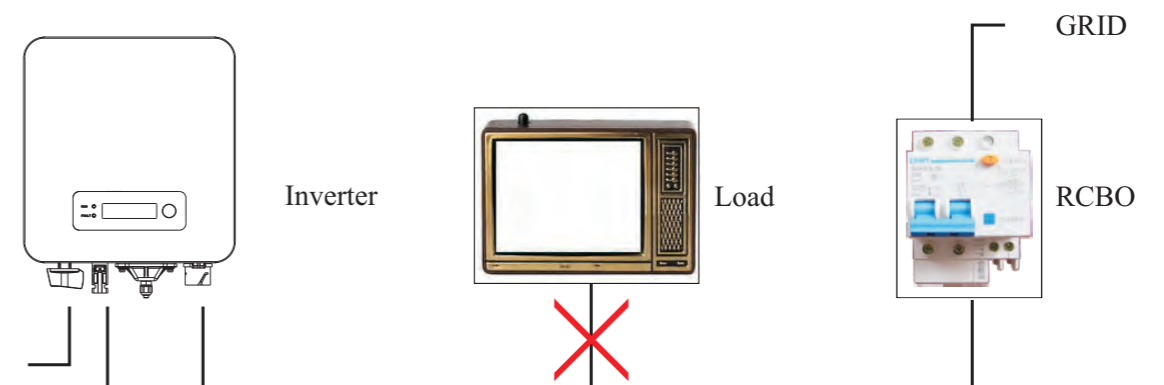
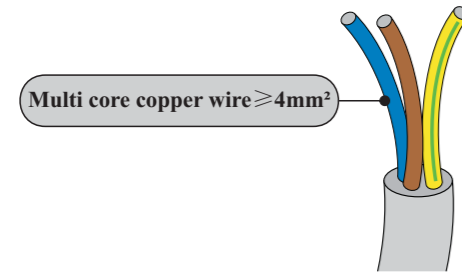

Table4-2 Recommended AC output cable specifications

Model	SOFAR 1100TL-G3	SOFAR 1600TL-G3	SOFAR 2200TL-G3	SOFAR 2700TL-G3	SOFAR 3000TL-G3	SOFAR 3300TL-G3
Cable(Copper)	≥ 4mm ²	≥ 4mm ²	≥ 4mm ²	≥ 6mm ²	≥ 6mm ²	≥ 6mm ²
Breaker	16A/400V	16A/400V	25A/400V	25A/400V	25A/400V	25A/400V

Multi core copper wire



AC cable should be correctly sized to ensure the power loss in AC cable is less than 1% of the rated power. If the resistance of the AC cable is too high, it will cause a huge increase in the AC voltage, which may lead to a disconnection of the inverter from the electrical grid. The relationship between power loss in AC cable and wire length, wire cross sectional area is shown in the following figure:

Figure 4-10 wire length, wire cross sectional area and wire power loss

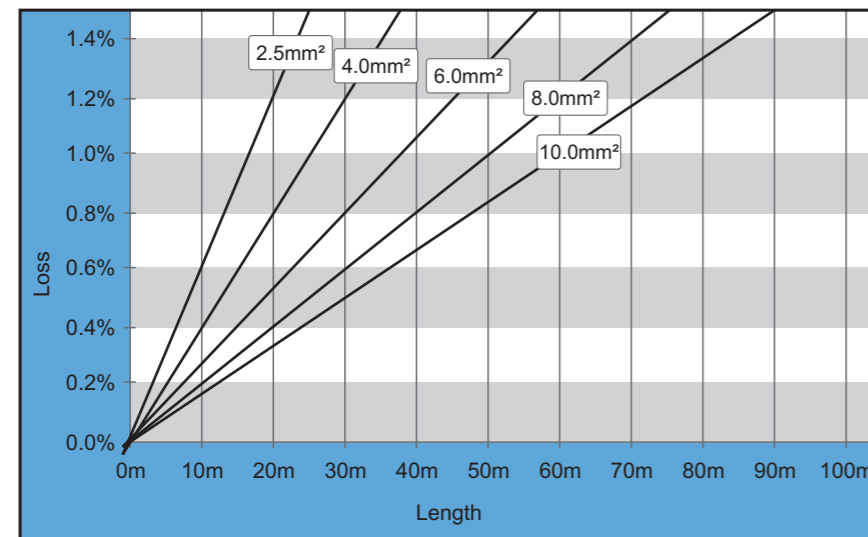

inverter is equipped with IP66 AC output connector dedicated for PV inverter, customer need to make AC output cable connections by himself, and the appearance of the AC connector is shown below:

Figure 4-11 AC output connector

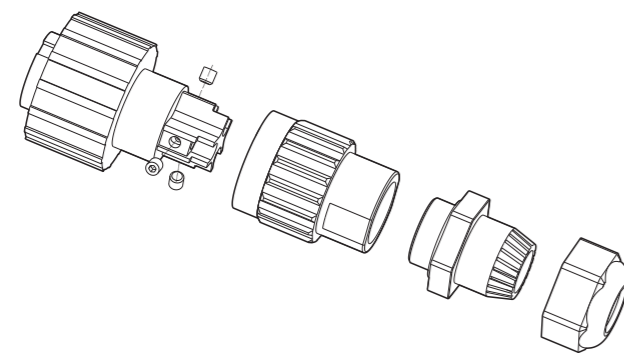

AC wire connections procedure:

Step 1 Select appropriate cables according to Table 4-2, Remove the insulation layer of the AC output cable using a wire stripper according to the figure shown below: A: 30~50mm B: 6~8mm;

Figure 4-12

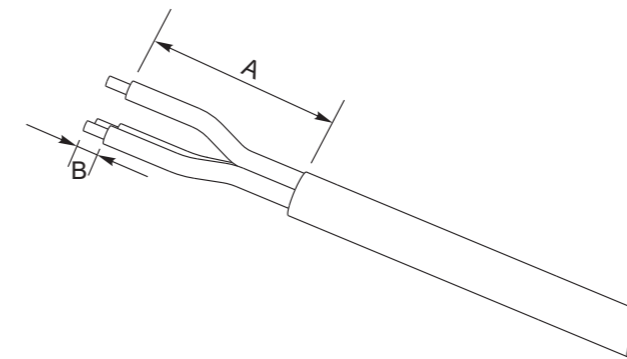

Step 2 Disassemble the AC connector according to the figure shown below: insert the AC output cable (with its insulation layer stripped according to step 1) through the waterproof locking cable gland;

Figure 4-13

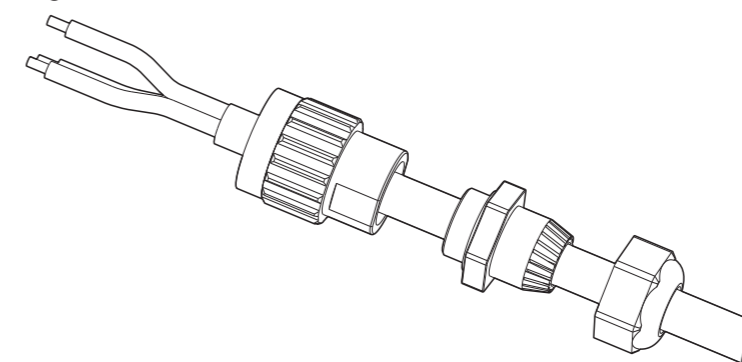

Step 3 Connect AC output cable as per the following requirements:

- Connect the yellow-green wire to the hole labeled 'PE', fasten the wire using an Allen wrench;
- Connect the brown wire to the hole labeled 'L', fasten the wire using an Allen wrench;
- Connect the blue wire to the hole labeled 'N', fasten the wire using an Allen wrench;

Figure 4-14

L--brown, N--blue, PE--yellow/green

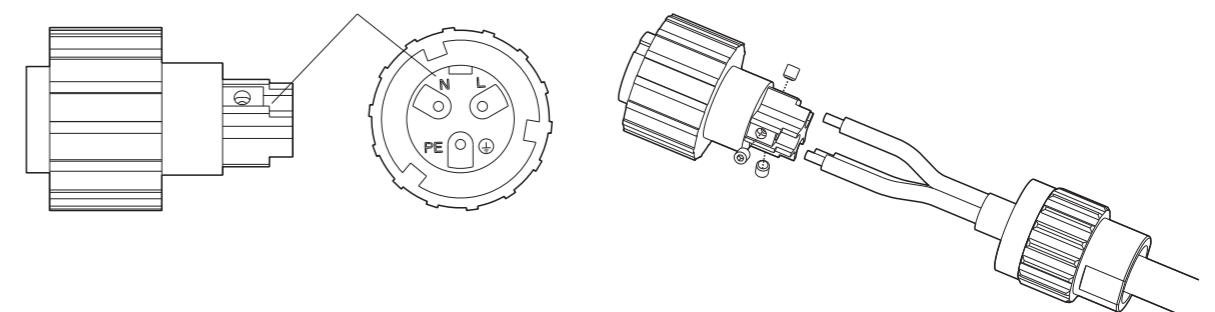

Step 4 Secure the locking cable gland clockwise, shown as below: make sure that all the wires are securely connected;

Step 5 Connect the AC output connector to the output wiring terminal of inverter, rotate the AC connector clockwise until the fastener reaches its designated position, as shown below:

Figure 4-15

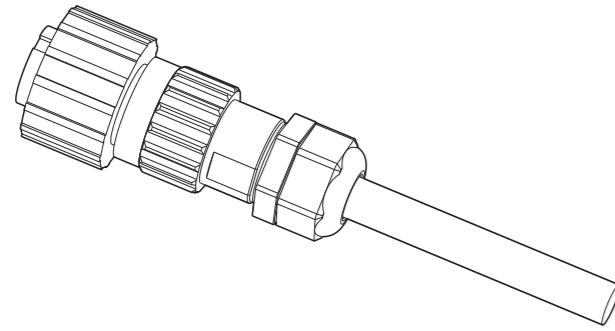

Step 4

Figure 4-16

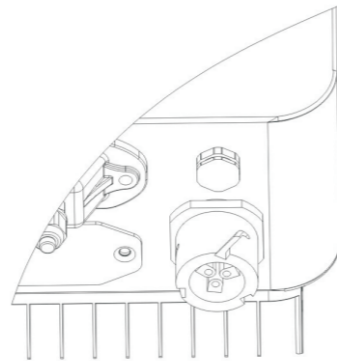

Step 5

4.5 RS485, CT, and Inverter logic interface connection

The communication interface location of the SOFAR1.1K~3.3KTL-G3 is shown in the figure below.

Figure 4-17

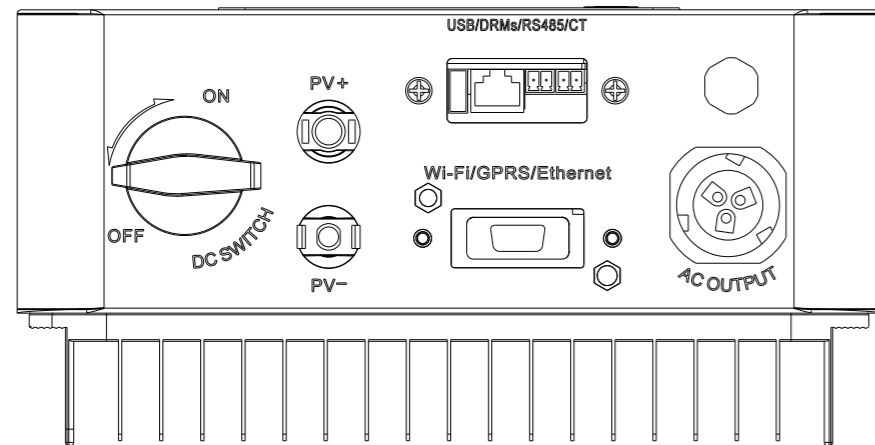

The wiring methods are the same for RS485 and CT, this part describes their wiring methods and logic interface methods.

Table 4-3 Recommended communication cable size are shown below

Communication function	RS485	CT
Cable size	0.5~1.5mm ²	0.5~1.5mm ²
Outside diameter	2.5~6mm	2.5~6mm

Step1 Remove the communication waterproof cover using a screwdriver;

Figure 4-18

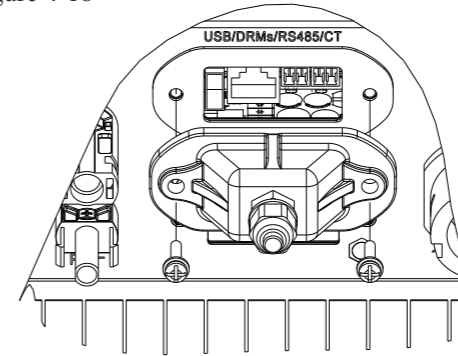

Step2 Unlock the waterproof cable gland, remove the stopper in the waterproof connector;

Figure 4-19

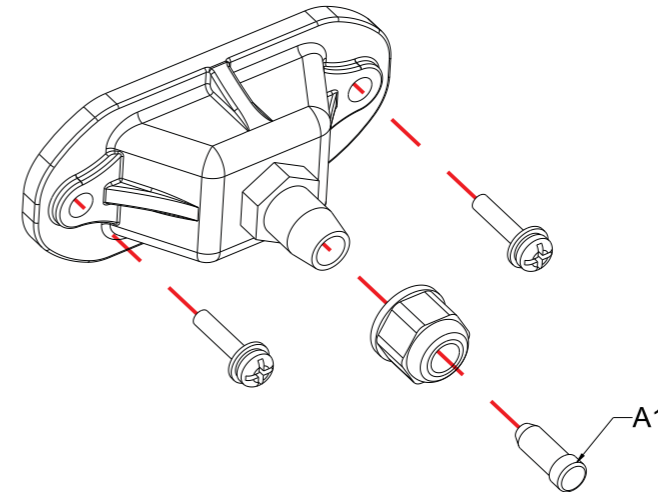

A1 : Waterproof stopper

Step3 Select appropriate cable according to Table 4-2, remove the insulation layer using a wire stripper, the length of the wire core is about 6mm, insert the cable through the cable gland and waterproof cover, according to Table 4-4, connect the wires as per the labels, and secure the wire using a slotted screwdriver as shown in the figure below:

Table 4-4 Function description of the communication terminals

Type	RS485		CT		Logic interface
Connector					
Label	TX-	TX+	CT-	CT+	The following table
Function	RS485 differential signal-	RS485 differential signal+	CT-	CT+	

Figure 4-20

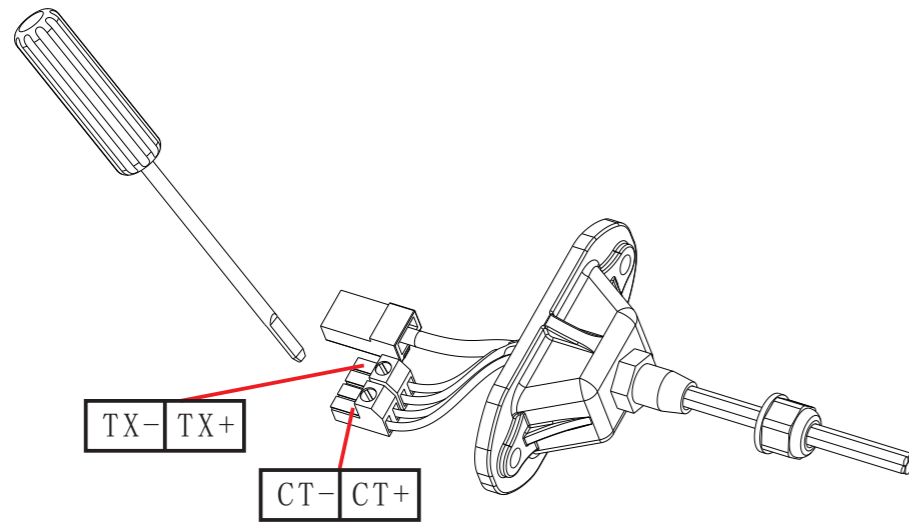

The logic interface pin definitions and circuit connections are as follows:

Logic interface pin are defined according to different standard requirements

(a) Logic interface for AS/NZS 4777. 2:2015, also known as inverter demand response modes (DRMs).

The inverter will detect and initiate a response to all supported demand response commands within 2 s. The inverter will continue to respond while the mode remains asserted.

Table 4-5 Function description of the DRMs terminal

Pin NO.	Color	Function
1	White and orange	DRM1/5
2	Orange	DRM2/6
3	White and green	DRM3/7
4	Blue	DRM4/8
5	White and blue	RefGen
6	Green	DRM0
7	White and brown	Pin7&Pin8 short internal
8	Brown	

NOTE: 1. 1~3. 3K-G3 Supported DRM command: DRM0, DRM5, DRM6, DRM7, DRM8.

(b) Logic interface for VDE-AR-N 4105: 2018-11, is in order to control and/or limit the inverter's output power.

The inverter can be connected to a RRCR (Radio Ripple Control Receiver) in order to dynamically limit the output power of all the inverters in the installation.

Figure 4-21 Inverter-RRCR Connection

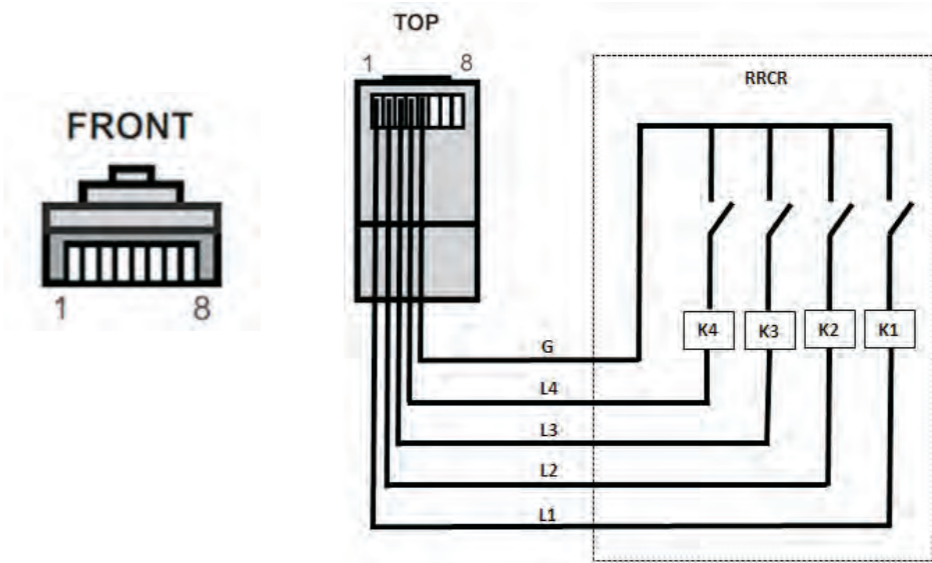

Table 4-6 Function description of the terminal

Pin NO.	Pin name	Description	Connected to (RRCR)
1	L1	Relay contact 1 input	K1 -Relay 1 output
2	L2	Relay contact 2 input	K2 -Relay 2 output
3	L3	Relay contact 3 input	K3 -Relay 3 output
4	L4	Relay contact 4 input	K4 -Relay 4 output
5	G	GND	Relays common node
6	NC	Not Connected	Not Connected
7	NC	Not Connected	Not Connected
8	NC	Not Connected	Not Connected

Table 4-7 The inverter is preconfigured to the following RRCR power levels
Relay status: close is 1, open is 0

L1	L2	L3	L4	Active Power	Cos (φ)
1	0	0	0	0%	1
0	1	0	0	30%	1
0	0	1	0	60%	1
0	0	0	1	100%	1

(c) Logic interface for EN50549-1: 2019, is in order to cease active power output within five seconds following an instruction being received at the input interface.

Figure 4-22 Inverter-RRCR Connection

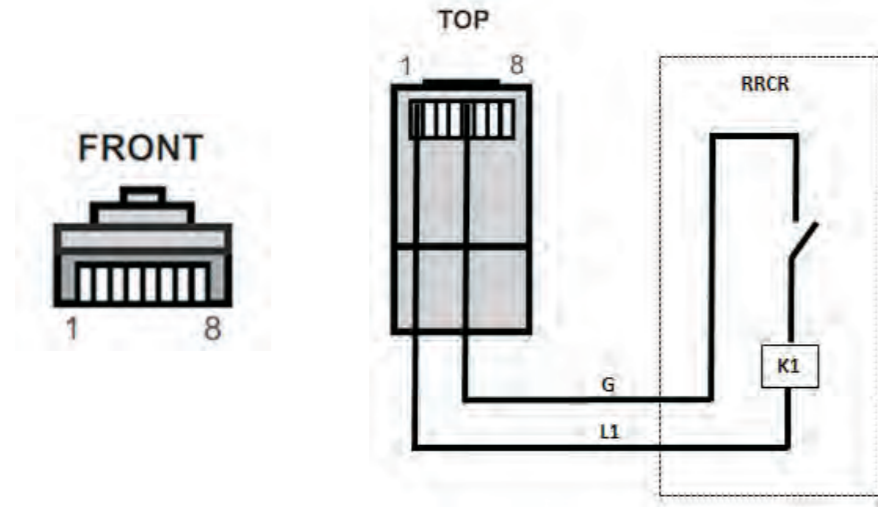

Table 4-8 Function description of the terminal

Pin NO.	Pin name	Description	Connected to (RRCR)
1	L1	Relay contact 1 input	K1 -Relay 1 output
2	NC	Not Connected	Not Connected
3	NC	Not Connected	Not Connected
4	NC	Not Connected	Not Connected
5	G	GND	K1 -Relay 1 output
6	NC	Not Connected	Not Connected
7	NC	Not Connected	Not Connected
8	NC	Not Connected	Not Connected

Table 4-9 The inverter is preconfigured to the following RRCR power levels
Relay status: close is 1, open is 0

L1	Active Power	Power drop rate	Cos (φ)
1	0%	< 5seconds	1
0	100%	/	1

Step4 Insert the terminal as per the printed label, and then tighten the screws to fix the waterproof cover, rotate the cable gland clockwise to fasten it securely.

Figure 4-23

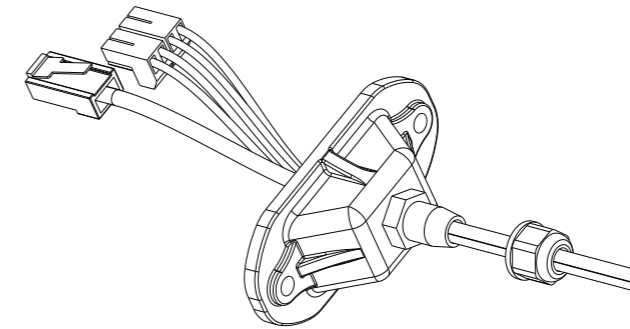
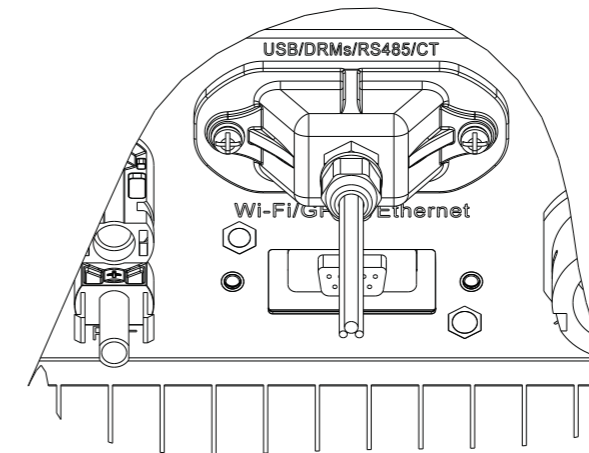

Figure 4-24



4.6 WIFI/GPRS module installation procedure:

- Step1: Remove wifi/GPRS waterproof cover using screw driver.
- Step2: Install WIFI/GPRS module.
- Step3: Fasten WIFI/GPRS module using screws.

Figure 4-25

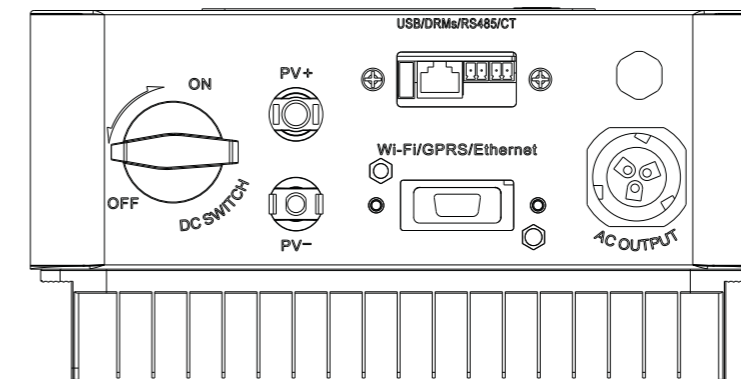
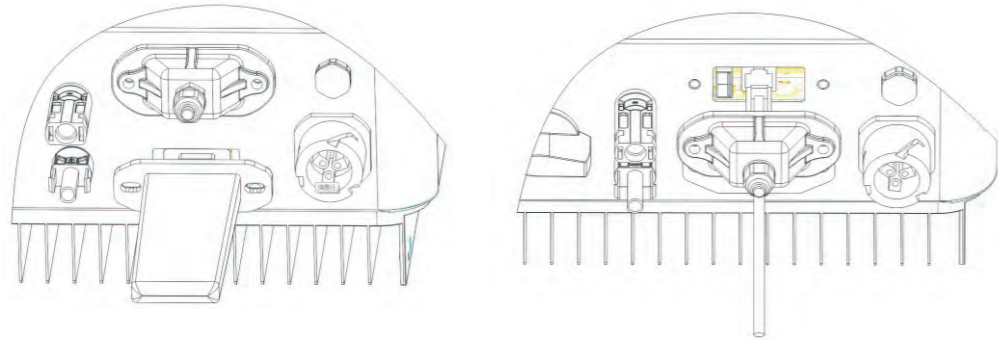

Figure 4-26



4.7 Communication method

SOFAR 1.1K~3.3KTL-G3 grid-connected inverters offer RS485 (standard) and Wi-Fi (optional) communication modes:

A. Communication between one inverter and one PC:

1. RS485

Refer to the figure shown below, connect the TX+ and TX- of the inverter to the TX+ and TX- of the RS485→USB adapter, and connect the USB port of the adapter to the computer.(NOTE1)

Figure 4-27

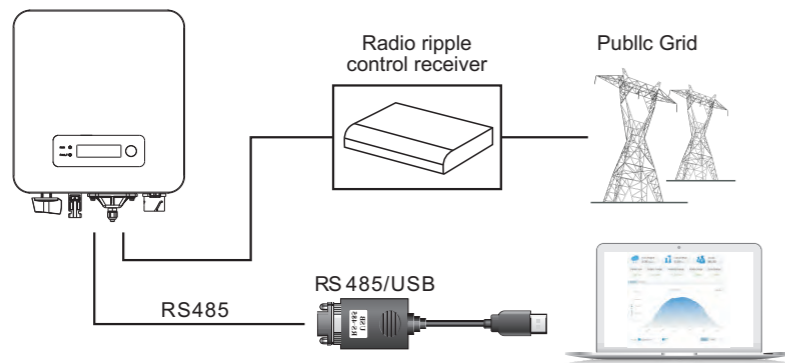

2. WI-FI

Refer to the figure shown below: (wireless function required for the PC).(NOTE4)

Figure 4-28



The operation information (generated energy, alert, operation status) of the inverter can be transferred to PC or uploaded to the server via Wi-Fi. You can register on the website.

http://www.solarmanpv.com/portal/Register/Regi_Pub.aspx

Using the Wi-Fi S/N number(NOTE3), then you can login the website:

<http://www.solarmanpv.com/portal/LoginPage.aspx> to remote monitors the inverter.

B. Communication between multiple inverters and one PC:

1. RS485

Refer to the following figure: RS485 wires are connected in parallel between inverters, refer to section 4.5 of this manual for wire connection methods. Connect the TX+ and TX- of the inverter to the TX+ and TX- of the RS485→USB adapter; connect the USB port of the adapter to the computer. A maximum of 31 inverters can be connected in one daisy chain.(NOTE2)

Figure 4-29

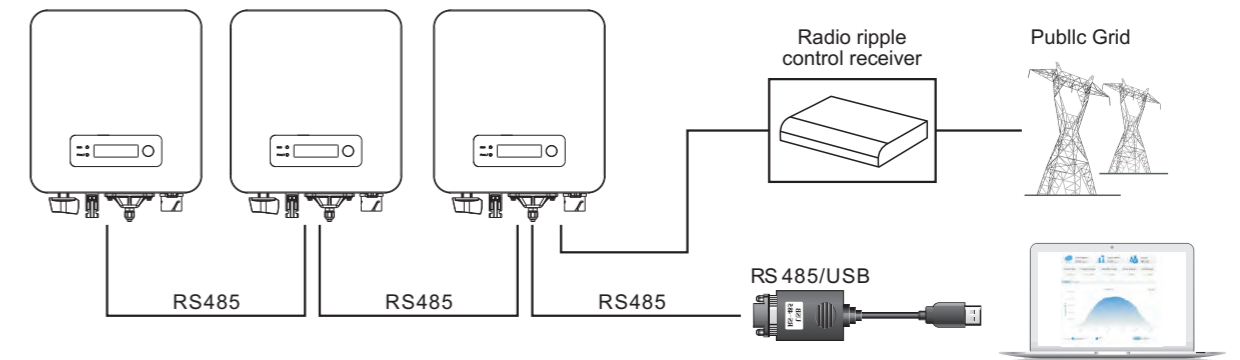

2. WI-FI

Refer to the figure shown below: (wireless function required for the PC).(NOTE4)

Figure 4-30

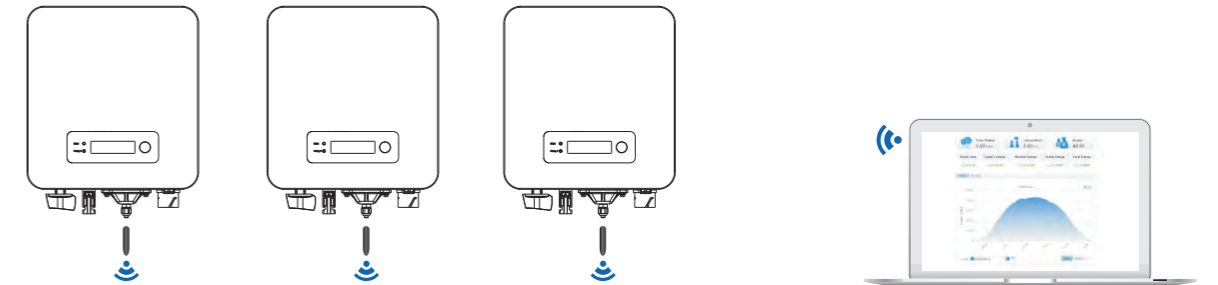

The operation information (generated energy, alert, operation status) of the inverter can be transferred to PC or uploaded to the server via Wi-Fi. You can register on the website.

http://www.solarmanpv.com/portal/Register/Regi_Pub.aspx

Using the Wi-Fi S/N number(NOTE3), then you can login the website:

<http://www.solarmanpv.com/portal/LoginPage.aspx> to remote monitors the inverter.



Note1:

The length of the RS485 communication cable should be less than 1000 m.



Note2:

When multiple inverters are connected via RS485 wires, set mod-bus address to differentiate the inverters.



Note3:

S/N number of the Wi-Fi module is located on the side.

5 Commissioning of inverter

5.1 Safety inspection before commissioning

	<p>Ensure that DC and AC voltages are within the acceptable range of the inverter.</p>
<p>Attention</p>	

5.2 Start inverter

Step 1: Turn ON the DC switch.(optional)

Step 2: Turn ON the AC circuit breaker.

When the DC power generated by the solar array is adequate, the SOFAR 1.1K~3.3KTL-G3 inverter will start automatically. Screen showing “normal” indicates correct operation.

NOTE: Choose the correct country code. (refer to section 6.3 of this manual)

Notice: Different distribution network operators in different countries have different requirements regarding grid connections of PV grid connected inverters.

Therefore, it's very important to make sure that you have selected the correct country code according to requirements of local authority.

Please consult qualified electrical engineer or personnel from electrical safety authorities about this.

Shenzhen SOFARSOLAR Co., Ltd. is not responsible for any consequences arising out of incorrect country code selection.

If the inverter indicates any fault, please refer to Section 7.1 of this manual — trouble shooting for help.

6 Operation interface

Outlines of this chapter

This section introduces the display, operation, buttons and LED indicator lights of SOFAR 1.1K~3.3KTL-G3 Inverter.

6.1 Operation and Display Panel

- Buttons and Indicator lights



Button:

Long press the button to enter the next menu or confirm the selection
 Short press the button to achieve the next page turning function
 Turn down the loop once to exit

Indicator Lights:

RUN (Green)
 ON: “ Normal ” state
 Flash: “ Wait ” or “ Check ”state

FAULT (Red)
 ON: “ Fault ” or “ Permanent ”state

6.2 Standard Interface

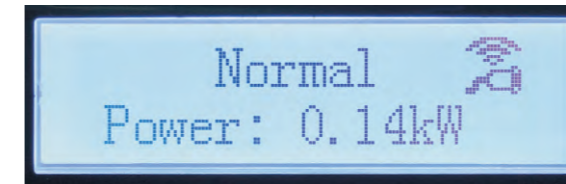
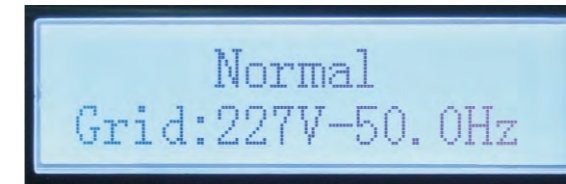
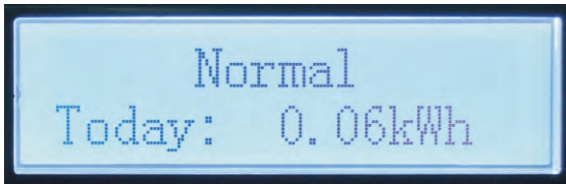
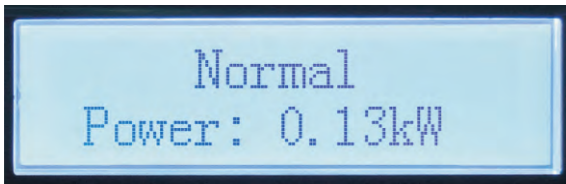

When power-on, LCD interface displays INITIALIZING, refer below picture.

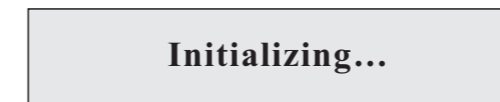

when control board successfully connected with communication board, the LCD display the current state of the inverter, display as shown in the figure below.



• Waiting States, Countdown 10S
(depends country code, some are 60s)

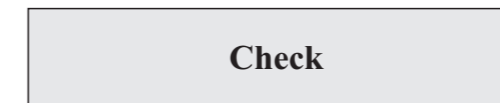

• Checking

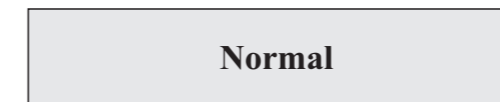

• Normal Power Generation

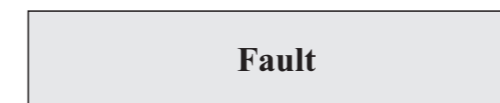

• Regular error state



• Unrecoverable error state

Inverter states includes: wait、 check、 normal、 fault and permanent

Wait : Inverter is waiting to Check State at the end of reconnection time. In this state, grid voltage value is between the max and min limits and so on; If not, Inverter will go to Fault State or Permanent State.

Check: Inverter is checking isolation resistor, relays, and other safety requirements. It also does self-test to ensure inverter software and hardware are functional. Inverter will go to Fault State or Permanent State if any error or fault occurs.

Normal : Inverter enter to Normal State, it is feeding power to the grid; inverter will go to Fault State or Permanent state if any error or fault occurs.

Fault : Fault State: Inverter has encountered recoverable error. It should recover if the errors disappear. If Fault State continues; please check the inverter according error code.

Permanent : Inverter has encountered unrecoverable error, we need maintainer debug this kind of error according to error code.

When the control board and communication board connection fails, the LCD display interface as shown in the figure below.



6.3 Main Interface

Press “Back” button under standard interface to enter into main interface, including:

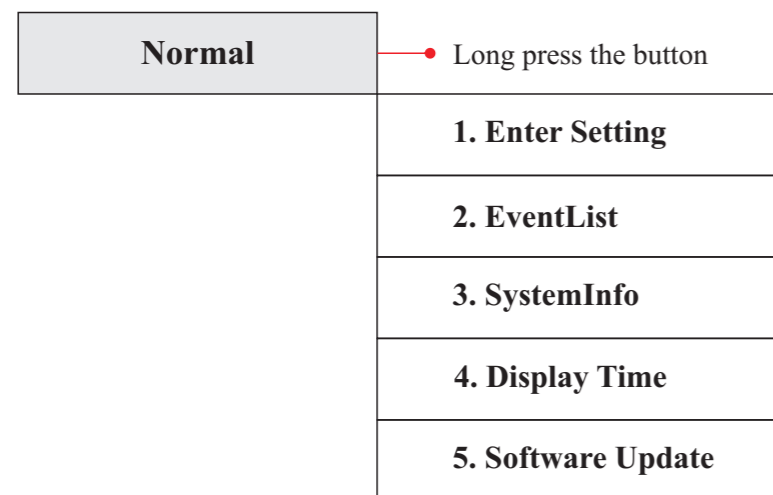

(A) “Enter Setting” Interface as below:

1.Enter Setting	1. Set time	12. Set Safety Voltage
	2. Clear Energy	13. Set Safety Frequency
	3. Clear Events	14. Insulation Resistance
	4. Set Country	15. Set Reactive
	5. On-Off Control	16. Set Power Derate
	6. Enable Set Country	17. Reflux Power
	7. Set Energy	18. MPPT Scan
	8. Set Address	19.DRMs0 Control
	9. Set Input mode	20.Set Power Ratio (The country is set at 10)
	10. Set Language	21. Relay Command
	11. Set Start Parameter	22. Relay Test

1. Set Time

Users long press the button to enter “1.Enter Setting” interface, long press the button to enter main setting interface. Enter “1. Set Time”by long press the button, then can start to set up time.

Time set from year, month, day, minutes, and seconds in turns, Short press the button to change different value,Set each value is need to long press the button to confirm setting. “success” is displayed if the setting time is correct, “fail” means failure settings.

2. Clear Energy

Users long press the button to enter “1.Enter Setting” interface, long press the button to enter main setting interface. Then Enter “2.Clear Energy” by short press the button to turn the page and long press the button to confirm. Long press the button to enter password 0001 by short press the button to change different value, and then long press the button to start to clear produce. “success” is displayed after settings.

3. Clear Events

Users long press the button to enter “1.Enter Setting” interface, long press the button to enter main setting interface.Enter “3. Clear Events” by short press the button to turn the page and long press the button to confirm. Long press the button and start to clear events. “success” is displayed after settings.

4. Set Country

Users long press the button to enter “1.Enter setting” interface, long press the button to enter main setting interface. Enter “4.Set Country ” by short press the button to turn the page and long press the button to confirm. If it's shown "set disable" on the screen, then you can NOT choose the operating country, you should enable country setting through "6. Enable Set Country" interface. If it's shown "set Country code?" on the screen, then long press the button to confirm to start country setting. "Success" will be shown on the screen after a successful country setting.

Table6-1 country code setting

code	country	code	country	code	country
00	Germany VDE AR-N4105	12	Poland	24	Cyprus
01	CEI0-21 Internal	13	Germany BDEW	25	India
02	Australia	14	Germany VDE 0126	26	Philippines
03	Spain RD1699	15	Italy CEI0-16	27	NewZealand
04	Turkey	16	UK-G83	28	Brazil
05	Denmark	17	Greece island	29	Slovakia VSD
06	Greece Continent	18	EU EN50438	30	Slovakia SSE
07	Netherland	19	IEC EN61727	31	Slovakia ZSD
08	Belgium	20	Korea	32	CEI0-21 In Areti
09	UK-G59t	21	Sweden	33	Ukraine
10	China	22	Europe General		
11	France	23	CEI0-21 External		

5. On-Off Control

Users long press the button to enter 1.Enter setting” interface, long press the button to enter main setting interface. Enter “5.On-Off Control” by short press the button to turn the page and long press the button to confirm, then enter “Input Password” Setting interface. Long press the button to set passwords (default: 0001), short press the button to change different value, long press the button to next value setting. “Error! ” Try again” will be displayed for wrong passwords. Long press the button and rekey in the correct passwords. “Success” will be displayed if setting successfully.

6. Enable Set Country

Users long press the button to enter “1.Enter setting” interface, long press the button to enter main setting interface. Enter “6.Enable Set Country” by short press the button to turn the page and long press the button to confirm, then enter “Input Password” Setting interface. Long press the button to set passwords (default: 0001), short press the button to change different value, long press the button to next value setting. “Error!” Try again” will be displayed for wrong passwords. Long press the button and rekey in the correct passwords. “Success” will be displayed if setting successfully.

Attention: when inverter working for power generation over 24h, country setting is forbidden, it can only be set after LCD setting. Key in passwords for country setting through LCD (default: 0001), country setting can be set in 24h after keying in the correct passwords, over 24h, set through LCD again.

7. Set Energy

Users long press the button to enter “1.Enter setting” interface, long press the button to enter main setting interface. Enter “7. Set Energy” by short press the button to turn the page and long press the button to confirm, then enter “Input Password” Setting interface. Long press the button to set passwords (default: 0001), short press the button to change different value, long press the button to next value setting. “Error! Try again” will be displayed for wrong passwords. Long press the button and rekey in the correct passwords then set total energy. “Success” or “fail” is displayed after setting.

8. Set address

Users long press the button to enter “1.Enter setting” interface, long press the button to enter main setting interface. Enter “8. Set address” by short press the button to turn the page and long press the button to confirm enter setting interface. Choose corresponded setting items by short press the button, then long press the button to confirm. “Success” or “fail” is displayed after setting.

9. Set Input mode

For SOFAR 1.1K ~ 3.3KTL-G3, this function is not applicable.

10. Set Language

Users long press the button to enter “1.Enter setting” interface, long press the button to enter main setting interface. Enter “10. Set Language” by short press the button to turn the page and long press the button to confirm enter setting interface. Choose corresponded setting items by short press the button. “Success” or “fail” is displayed after setting.

11. Set Start Parameter

User can change the start parameter by the LCD. First the User need to copy the .TXT file which is used to change the start parameter to the SD card .

Users long press the button to enter “1.Enter setting” interface, long press the button to enter main setting interface. Enter “11. Set Start Parameter” by short press the button to turn the page and long press the button to confirm, then enter “Input Password” Setting interface. Long press the button to set passwords (default: 0001), short press the button to change different value, long press the button to next value setting. “Error!” Try again” will be displayed for wrong passwords. Long press the button and rekey in the correct passwords. “Success” will be displayed if setting successfully.

12. Set Safety Voltage

User can change the Voltage protection point by the LCD. First the User need to copy the. TXT file which is used to change the Voltage protection point to the SD card .

Users long press the button to enter “1.Enter setting” interface, long press the button to enter main setting interface. Enter “12. Set Safety Voltage” by short press the button to turn the page and long press the button to confirm, then enter “Input Password” Setting interface. Long press the button to set passwords (default: 0001), short press the button to change different value, long press the button to next value setting. “Error!” Try again” will be displayed for wrong passwords. Long press the button and rekey in the correct passwords. “Success” will be displayed if setting successfully.

13. Set Safety Frequency

User can change the Frequency protection point by the LCD. First the User need to copy the. TXT file which is used to change the Frequency protection point to the SD card .

Users long press the button to enter “1.Enter setting” interface, long press the button to enter main setting interface. Enter “13. Set Safety Frequency” by short press the button to turn the page and long press the button to confirm, then enter “Input Password” Setting interface. Long press the button to set passwords (default: 0001), short press the button to change different value, long press the button to next value setting. “Error!” Try again” will be displayed for wrong passwords. Long press the button and rekey in the correct passwords. “Success” will be displayed if setting successfully.

14. Insulation Resistance

User can change the Insulation protection point by the LCD. First the User need to copy the. TXT file which is used to change the Insulation protection point to the SD card .

Users long press the button to enter “1.Enter setting” interface, long press the button to enter main setting interface. Enter “14. Set Insulation” by short press the button to turn the page and long press the button to confirm, then enter “Input Password” Setting interface. Long press the button to set passwords (default: 0001), short press the button to change different value, long press the button to next value setting. “Error!” Try again” will be displayed for wrong passwords. Long press the button and rekey in the correct passwords. “Success” will be displayed if setting successfully.

15. Set Reactive

Users long press the button to enter “1.Enter Setting” interface, long press the button to enter main setting interface. Enter “15.Set Reactive” by short press the button to turn the page and long press the button to confirm, then enter “Input Password” Setting interface. Long press the button to set passwords (default: 0001), short press the button to change different value, long press the button to next value setting. “Error!” Try again” will be displayed for wrong passwords. Long press the button and rekey in the correct passwords. “Success” will be displayed if setting successfully.

16. Set Power Derate

Users long press the button to enter “1.Enter Setting” interface, long press the button to enter main setting interface. Enter “16.Set Power Derate” by short press the button to turn the page and long press the button to confirm, then enter “Input Password” Setting interface. Long press the button to set passwords (default: 0001), short press the button to change different value, long press the button to next value setting. “Error!” Try again” will be displayed for wrong passwords. Long press the button and rekey in the correct passwords. “Success” will be displayed if setting successfully.

17. Reflux Power

Users long press the button to enter “1.Enter Setting” interface, long press the button to enter main setting interface. Enter “17.Reflux Power ” by short press the button to turn the page and long press the button to confirm, then enter “Input Password” Setting interface. Long press the button to set passwords (default: 0001), short press the button to change different value, long press the button to next value setting. “Error!” Try again” will be displayed for wrong passwords. Long press the button and rekey in the correct passwords. “Success” will be displayed if setting successfully.

18. MPPT Scan

Users long press the button to enter 1.Enter setting” interface, long press the button to enter main setting interface. Enter 18.MPPT Scan” by short press the button to turn the page and long press the button to confirm, then enter “Input Password” Setting interface. Long press the button to set passwords (default: 0001), short press the button to change different value, long press the button to next value setting. “Error!” Try again” will be displayed for wrong passwords. Long press the button and rekey in the correct passwords. “Success” will be displayed if setting successfully.

19. DRMs0 Control

Users long press the button to enter 1.Enter setting” interface, long press the button to enter main setting interface. Enter 19.DRMs0 Control” by short press the button to turn the page and long press the button to confirm, then enter “Input Password” Setting interface. Long press the button to set passwords (default: 0001), short press the button to change different value, long press the button to next value setting. “Error!” Try again” will be displayed for wrong passwords. Long press the button and rekey in the correct passwords. “Success” will be displayed if setting successfully.

20. Set Power Ratio (The country is set at 10)

Users long press the button to enter 1.Enter setting” interface, long press the button to enter main setting interface. Enter “20.Set Power Ratio” by short press the button to turn the page and long press the button to confirm, then enter “Input Password” Setting interface. Long press the button to set passwords (default: 0001), short press the button to change different value, long press the button to next value setting. “Error!” Try again” will be displayed for wrong passwords. Long press the button and rekey in the correct passwords. “Success” will be displayed if setting successfully.

21. Relay Command

Users long press the button to enter “1.Enter setting” interface, long press the button to enter main setting interface. Enter “21. Relay Command” by short press the button to turn the page and long press the button to confirm, then enter “Relay Command setting” interface. Choose corresponded setting items by short press the button, then long press the button. “Success”or “fail” is displayed after setting.

22. Relay Test

Users long press the button to enter “1.Enter setting” interface, long press the button to enter main setting interface. Enter “22. Relay Test” by short press the button to turn the page,then long press the button and start test relay. “Success” will be displayed if setting successfully.

(B) “Event List” Interface as below:

Event List is used to display the real-time event records, including the total number of events and each specific ID No. and happening time. User can enter Event List interface through main interface to check details of real-time event records, Event will be listed by the happening time, and recent events will be listed in the front. Please refer to below picture. Long press the button and short press the button to turn the page in standard interface, then enter into “2.Event List” interface.

2. Event List	
1. Current event	2. History event
Fault information	01 ID04 06150825 (Display the event sequence number, event ID number, and event occurrence time)

(C) “SystemInfo” Interface as below:

3.SystemInfo	
1.Inverter Type	7.Input Mode
2.Serial Number	8.Power Factor
3.SoftVersion	9.Reflux Power
4.HardVersion	10.Safety Paras
5.Country	11.MPPT Scan
6.Modbus Address	12.Power Ratio (The country is set at 10)
	13.Relay Command

1. Inverter Type

Users short press the button to enter “3. SystemInfo”interface, then long press the button to enter into system information checking interface,then short press the button to enter into“1. Inverter Type”,then long press the button , the Inverter Type will be displayed.

2. Serial Number

Users short press the button to enter “3. SystemInfo”interface, then long press the button to enter into system information checking interface,then short press the button to enter into“2. Serial Number”,then long press the button ,the serial number will be displayed.

3. SoftVersion

Users short press the button to enter “3. SystemInfo” interface, then long press the button to enter into system information checking interface,then short press the button enter into“3. SoftVersion”,then long press the button , the SoftVersion will be displayed.

4. HardVersion

Users short press the button to enter “3. SystemInfo” interface, then long press the button to enter into system information checking interface,then short press the button enter into“4. HardVersion”,then long press the button , the HardVersion will be displayed.

5. Country

sers short press the button to enter “3. SystemInfo” interface, then long press the button to enter into system information checking interface,then short press the button enter into “5. Country”, then long press the button , the Country will be displayed.

6. Modbus Address

Users short press the button to enter 3. SystemInfo”interface, then long press the button to enter into system information checking interface,then short press the button enter into “6.Modbus Address”,then long press the button , the Modbus Address will be displayed.

7. Input Mode

FOR SOFAR 1.1~3.3KTL-G3,this function is not applicable.

8.Power Factor

Users short press the button to enter “3. SystemInfo” interface, then long press the button to enter into system information checking interface,then short press the button enter into “8. Power Factor”,then long press the button , the Power Factor will be displayed.

9. Reflux Power

Users short press the button to enter “3. SystemInfo” interface, then long press the button to enter into system information checking interface,then short press the button enter into “9. Reflux Power”,then long press the button , the Reflux Power will be displayed.

10. Safety Paras

Users short press the button to enter 3. SystemInfo” interface,then long press the button to enter into system information checking interface,then short press the button enter into“10.Safety Paras ”,then long press the button , the Safety Paras will be displayed.

11. MPPT Scan

Users short press the button to enter 3. SystemInfo” interface,then long press the button to enter into system information checking interface,then short press the button enter into“11.MPPT Scan”, then long press the button, the information of MPPT Scan will be displayed.

12. Power Ratio (The country is set at 10)

Users short press the button to enter 3. SystemInfo” interface, then long press the button to enter into system information checking interface,then short press the button enter into“12. Power Ratio ”, then long press the button , the Power Ratio will be displayed.

13. Relay Command

Users short press the button to enter 3. SystemInfo” interface, then long press the button to enter into system information checking interface,then short press the button enter into“13. Relay Command ”, then long press the button , the Relay Command Mode will be displayed.

(D) Display Time

Long press the button and short press the button to turn the page in the standard user interface to enter into “4.Display Time”,then long press the button to display the current system time.

(E) Software Update

Long press the button and short press the button to turn the page in the standard user interface to enter into “5. Software Update”, then long press the button to enter into the “ input password ” interface, now long press the button to input the password(initial passwords is 0715),short press the button to change the value, then long press the button to confirm the current value of input and enter the next set of value .when set over, if the password is wrong, the LCD will display “Error! Try again”, at this time ,you should re-enter your password .If the password is correct , then begin the update process.

6.4 Update Software online

SOFAR 1.1K~3.3KTL-G3 inverters offer software upgrade via usb flash drive to maximize inverter performance and avoid inverter operation error caused by software bugs.

Procedure:

Step 1 First,turn off the DC and AC breaker,and then remove the communication waterproof cover as the following picture.If the RS485 line has been connected,Be sure to release the waterproof nut,Make sure the communication line is no longer the force. Then remove the waterproof cover,In order to avoid loosening the communication plug which has been connected.

Figure 6-1

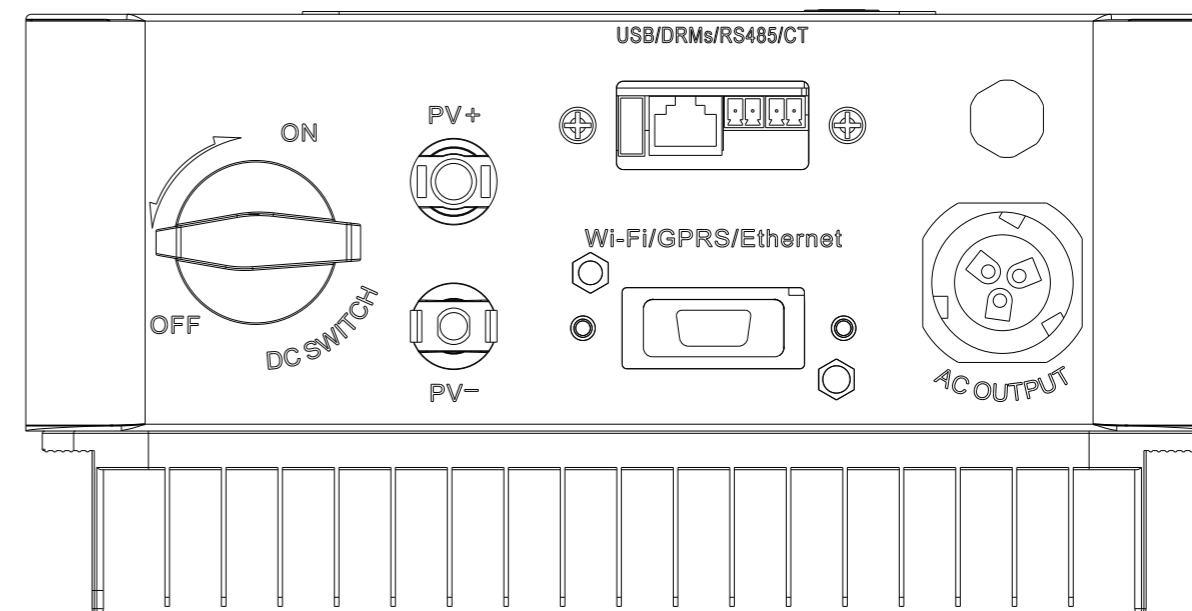

Step 2 Insert the usb flash drive into the computer.

Step 3 SOFAR SOLAR will send the Software code to the user who needs to update. After user receive the file, please decompressing file and cover the original file in usb flash drive.

Step 4 Insert the usb flash drive into the USB interface.

Step 5 Then turn on DC switch and enter into the online upgrade to the main menu "5.Software Update" in the LCD display program [6.3(E)]. The method to enter the menu can refer to operation interface of LCD.

Step 6 Input the password, if password is correct, and then begin the update process, the original password is 0715.

Step 7 System update main DSP, slave DSP and ARM in turns. If main DSP update success, the LCD will display "Update DSP1 Success", otherwise display "Update DSP1 Fail"; If slave DSP update success, the LCD will display "Update DSP2 Success", otherwise display "Update DSP2 Fail".

Step 8 If Fail, please turn off the DC breaker, wait for the LCD screen extinguish, then turn on the DC breaker again, then Continue to update from step 5.

Step 9 After the update is completed, turn off the DC breaker, wait for the LCD screen extinguish, then recover the communication waterproof and then turn on the DC breaker and AC breaker again, the inverter will enter the running state. User can check the current software version in SystemInfo >> 3.SoftVersion.

7 Trouble shooting and maintenance

Outlines of this chapter

This topic describes how to perform daily maintenance and troubleshooting to ensure long term proper operation of the inverter.

7.1 Trouble shooting

This section contains information and procedures for solving possible problems with the inverter.

☉ This section help users to identify the inverter fault. Please read the following procedures carefully:

- Check the warning, fault messages or fault codes shown on the inverter screen, record all the fault information.
- If there is no fault information shown on the screen, check whether the following requirements are met:
 - Is the inverter mounted in a clean, dry place with good ventilation?
 - Is the DC switch turned ON?
 - Are the cables adequately sized and short enough?
 - Are the input and output connections and wiring in good condition?
 - Are the configuration settings correct for the particular installation?
 - Are the display panel and the communication cables properly connected and undamaged?

Follow the steps below to view recorded problems:

Long press the button to enter the main menu from the standard interface. Select “ 2. Event List ” then long press the button to enter event list.

☉ EventList information

Table 7-1 Eventlist

EventList NO.	EventList Name	EventList description	solution
ID01	GridOVP	The power grid voltage is too high	<ul style="list-style-type: none"> • If the alarm occurs occasionally, the possible cause is that the electric grid is abnormal occasionally. inverter automatically returns to normal operating status when the electric grid's back to normal. • If the alarm occurs frequently, check whether the grid voltage/frequency is within the acceptable range. If no, contact technical support. If yes, check the AC circuit breaker and AC wiring of the inverter. • If the grid voltage/frequency is within the acceptable range and AC wiring is correct, while the alarm occurs repeatedly, contact technical support to change the grid over-voltage, under-voltage, over-frequency, under-frequency protection points after obtaining approval from the local electrical grid operator.
ID02	GridUVP	The power grid voltage is too low	
ID03	GridOFP	The power grid frequency is too high	
ID04	GridUFP	The power grid frequency is too low	

ID05	PVUVP	The input voltage is too low	Check whether too few PV modules are series connected in a PV string, thus the voltage(Vmp) of the PV string is lower than the minimum operating voltage of inverter. If yes, adjust the number of series connected PV modules to increase the voltage of the PV string to fit the input voltage range of inverter. inverter automatically returns to normal operating status after correct adjustments.
ID09	PvOVP	The input voltage is too high	Check whether too many PV modules are series connected in a PV string, thus the voltage(Voc) of the PV string is higher than the maximum input voltage of inverter. If yes, adjust the number of series connected PV modules to decrease the voltage of the PV string to fit the input voltage range of inverter. inverter automatically returns to normal operating status after correct adjustments.
ID10	IpvUnbalance	Input current is not balanced	Check the input mode(parallel mode/ independent mode) setting of inverter according to Section 6.3 (C) 6.Input Mode of this user manual. If it's incorrect, change it according to Section 6.3 (A) 10.Set Input mode of this manual.
ID11	PvConfigSetWrong	Incorrect input mode	
ID12	GFCIFault	GFCI Fault	
ID14	HwBoostOCP	The input current is too high,and has happen hardware protection	Check whether the input current is higher than the maximum input current of inverters, then check the input wiring, if both are correct, please contact technical support.
ID15	HwAcOCP	The grid current is too high,and has happen hardware protection	ID15-ID24 are internal faults of inverter, turn OFF the “DC switch”, wait for 5 minutes, then turn ON the “DC switch”. Check whether the fault is rectified. If no, please contact technical support.
ID16	AcRmsOCP	The grid current is too high	
ID17	HwADFaultGrid	The grid current sampling error	
ID18	HwADFaultDCI	The DCI sampling error	
ID19	HwADFaultVGrid	The grid voltage sampling error	
ID20	GFCIDeviceFault	The GFCI sampling error	
ID21	MChip_Fault	The master chip fault	
ID22	HwAuxPowerFault	The auxiliary voltage error	
ID23	BusVoltZeroFault	The bus voltage sampling error	
ID24	IacRmsUnbalance	The Output current is not balanced	
ID25	BusUVP	The bus voltage Is too low	If the PV array configuration is correct (no ID05 fault), the possible cause is that the solar irradiance is too low. inverter automatically returns to normal operating status after the solar irradiance returns to normal level.

ID26	BusOVP	The bus voltage is too high	ID26-ID27 are internal faults of inverter, turn OFF the “DC switch”, wait for 5 minutes, then turn ON the “DC switch”. Check whether the fault is rectified. If no, please contact technical support.
ID27	VbusUnbalance	The bus voltage is not balanced	
ID28	DciOCP	The Dci is too high	<ul style="list-style-type: none"> Check the input mode(parallel mode/ independent mode) setting of inverter according to Section 6.3 (C) 6.Input Mode of this user manual, If it's incorrect, change it according to Section 6.3 (A) 10.Set Input mode of this manual. If the input mode is correct, turn OFF the “DC switch”, wait for 5 minutes, then turn ON the “DC switch”. Check whether the fault is rectified. If no, please contact technical support, If it's incorrect, change it according to Section 6.3 (A) 10.Set Input mode of this manual.
ID29	SwOCPIstant	The grid current is too high	Internal faults of inverter, turn OFF the “DC switch”, wait for 5 minutes, then turn ON the “DC switch”. Check whether the fault is rectified. If no, please contact technical support.
ID30	SwBOCPIstant	The input current is too high	Check whether the input current is higher than the maximum input current of inverters, then check the input wiring, if both are correct, please contact technical support.
ID49	ConsistentFault_VGrid	The grid voltage sampling value between the master DSP and slave DSP is not consistent	ID49-ID55 are internal faults of inverter, turn OFF the “DC switch”, wait for 5 minutes, then turn ON the “DC switch”. Check whether the fault is rectified. If no, please contact technical support.
ID50	ConsistentFault_FGrid	The grid frequency sampling value between the master DSP and slave DSP is not consistent	
ID51	ConsistentFault_DCI	The DCI sampling value between the master DSP and slave DSP is not consistent	
ID52	ConsistentFault_GFCI	The GFCI sampling value between the master DSP and slave DSP is not consistent	
ID53	SpiCommLose	The spi communication between the master DSP and slave DSP is fault	
ID54	SciCommLose	The Sci communication between the control board communication board is fault	
ID55	RelayTestFail	The relays fault	
ID56	PvIsoFault	The insulation resistance is too low	
ID57	OverTempFault_Inv	The inverter temp is too high	<ul style="list-style-type: none"> Ensure the installation position and installation method meet the requirements of Section 3.4 of this user manual. Check whether the ambient temperature of the installation position exceeds the upper limit. If yes, improve ventilation to decrease the temperature.
ID58	OverTempFault_Boost	The Boost temp is too high	
ID59	OverTempFault_Env	The environment temp is too high	
ID65	UnrecoverHwAcOCP	The grid current is too high, and has cause unrecoverable hardware fault	ID65-ID70 are internal faults of inverter, turn OFF the “DC switch”, wait for 5 minutes, then turn ON the “DC switch”. Check whether the fault is rectified. If no, please contact technical support.

ID66	UnrecoverBusOVP	The bus voltage is too high, and has cause unrecoverable fault	Check the input mode(parallel mode/ independent mode) setting of inverter according to Section 6.3 (C) 6.Input Mode of this user manual, If it's incorrect, change it according to Section 6.3 (A) 10.Set Input mode of this manual.
ID67	UnrecoverIacRmsUnbalance	The grid current is unbalance, and has cause unrecoverable fault	
ID68	UnrecoverIpvUnbalance	The input current is unbalance, and has cause unrecoverable fault	
ID69	UnrecoverVbusUnbalance	The bus voltage is unbalance, and has cause unrecoverable fault	
ID70	UnrecoverOCPIstant	The grid current is too high, and has cause unrecoverable fault	
ID71	UnrecoverPvConfigSetWrong	Incorrect input mode	
ID74	UnrecoverIPVInstant	The input current is too high, and has happen unrecoverable fault	
ID75	UnrecoverWRITEEEPROM	The EEPROM is unrecoverable	
ID76	UnrecoverREADEEPROM	The EEPROM is unrecoverable	
ID77	UnrecoverRelayFail	Relay has happen permanent fault	<ul style="list-style-type: none"> Ensure the installation position and installation method meet the requirements of Section 3.4 of this user manual. Check whether the ambient temperature of the installation position exceeds the upper limit. If yes, improve ventilation to decrease the temperature.
ID81	OverTempDerating	the inverter has derated because of the temperature is too high	
ID82	OverFreqDerating	the inverter has derated because of the grid frequency too high	inverter automatically reduce the output power when the frequency of electrical grid is too high.
ID83	RemoteDerating	The inverter has derated by the Remote control	inverter records ID83 in case of remote power derating operation. Check the wiring of remote input and output control signal port on the communication board according to Section 4.5 of this user manual.
ID84	RemoteOff	The inverter has shut down because by the Remote control	inverter records ID84 in case of remote shutdown operation. Check the wiring of remote input and output control signal port on the communication board according to Section 4.5 of this user manual.
ID94	Software version is not consistent	The Software between the control board and the communication board is not consistent	Contact technical support to upgrade software.
ID95	Communication board EEPROM fault	The Communication board EEPROM is fault	ID95~ID96 are internal faults of inverter, turn OFF the “DC switch”, wait for 5 minutes, then turn ON the “DC switch”. Check whether the fault is rectified. If no, please contact technical support.
ID96	RTC clock chip anomaly	RTC clock chip is fault	
ID97	Invalid Country	The Country is InValid	Check the country setting according to Section 6.3 (C) 5.Country of this user manual, If it's incorrect, change it according to Section 6.3 (A) 4.Set Country Code of this manual.
ID98	SD fault	The SD card is fault	Please replace the SD card.

7.2 Maintenance

Inverters generally do not need any daily or routine maintenance. Heat sink should not be blocked by dust, dirt or any other items.

Before the cleaning, make sure that the DC SWITCH is turned OFF and the circuit breaker between inverter and electrical grid is turned OFF. Wait at least for 5 minutes before the cleaning.

- ◉ **Inverter cleaning**

Please clean the inverter with an air blower, a dry & soft cloth or a soft bristle brush. Do NOT clean the inverter with water, corrosive chemicals, detergent, etc.

- ◉ **Heat sink cleaning**

For the long-term proper operation of inverters, ensure there is enough space around the heat sink for ventilation, check the heat sink for blockage (dust, snow, etc.) and clean them if they exist. Please clean the heat sink with an air blower, a dry & soft cloth or a soft bristle brush. Do NOT clean the heat sink with water, corrosive chemicals, detergent, etc.

8 Technical data

Outlines of this chapter

This topic lists the technical specifications for all SOFAR 1.1K~3.3KTL-G3 inverters.

8.1 Input parameters (DC)

Technical Data	SOFAR 1100TL-G3	SOFAR 1600TL-G3	SOFAR 2200TL-G3	SOFAR 2700TL-G3	SOFAR 3000TL-G3	SOFAR 3300TL-G3
Max. DC power	1500W	2200W	3000W	3700W	4100W	4500W
Max. Input voltage	500V			550V		
Aux Start-up voltage	60V					
Start-up Input voltage	70V					
MPPT voltage range	50-500V			50-550V		
Rated input voltage	360V					
Full load DC voltage range	110-450V	150-450V	200-450V	250-500V	275-500V	300-500V
Max. Input current	12A					
Input short circuit current	15A					
MPPT number of ways/ input string number	1/1					
Input terminal type	MC4/H4					

8.2 Output parameters (AC)

Technical Data	SOFAR 1100TL-G3	SOFAR 1600TL-G3	SOFAR 2200TL-G3	SOFAR 2700TL-G3	SOFAR 3000TL-G3	SOFAR 3300TL-G3
Rated Output power	1100W	1600W	2200W	2700W	3000W	3300W
Max. Output power	1100VA	1600VA	2200VA	2700VA	3000VA	3300VA
Rated Output current	4.8A	7A	9.6A	11.8A	13A	14.3A
Max. Output current	5.3A	7.7A	10.6A	13A	14.5A	16A
Nominal grid voltage	L/N/PE, 220Vac 230Vac 240Vac					
Grid voltage range	180-276Vac(According to local grid standard)					
Nominal grid frequency	50Hz/60Hz					
Grid frequency range	45~55Hz/54~66Hz(According to local grid standard)					
THDi	<3%					
Power factor	1default (+/-0.8 adjustable)					

8.3 Efficiency, Protection and Communication

Technical Data	SOFAR 1100TL-G3	SOFAR 1600TL-G3	SOFAR 2200TL-G3	SOFAR 2700TL-G3	SOFAR 3000TL-G3	SOFAR 3300TL-G3
Max. Efficiency	97.7%					
Euro Efficiency	97.2%					
MPPT efficiency	>99.9%					
Self-consumption at night	<1w					
Safety protectio	Anti islanding,RCMU,Ground fault monitoring					
Certification	AS 4777, DE V 124-1 0 V 0 0 , VDE V 0126-1-1, VDE-AR-N 4105, EN 50438, G83/2, C10/11, RD 1699					
Protective class	Class I					
External environment pollution degree	Degree 3					
Overvoltage category	PV:OVC II, AC mains:OVC III					
Max inverter Back-feed current to the array	0A					
Output short circuit current and duration	200A/1us					
Output inrush current and duration	0.8A/2us					

8.4 General Data

Technical Data	SOFAR 1100TL-G3	SOFAR 1600TL-G3	SOFAR 2200TL-G3	SOFAR 2700TL-G3	SOFAR 3000TL-G3	SOFAR 3300TL-G3
Topology	Transformerless					
Ambient temperature range	-30-60°C					
Permissible humidity range	0~100%					
Noise figure	<25dB					
DC Switch	Optional					
Cooling	Natural convection					
Max. Operating altitude	2000m					
Outline Dimension	303*260.5* 118mm			321*260.5* 131.5mm		
Bracket	Wall-mounted					
Weight	5.5kg			6.3kg		
Display	LCD+LED					
Communication mode	RS485, WiFi/GPRS (optional), USB					
Degree of protection	IP65					
Warranty	3/5/7/10 years					

9 Quality Assurance

Standard warranty period

The standard warranty period of inverter is 60 months (5 years).There are two calculation methods for the warranty period:

1. Purchase invoice provided by the customer: the first flight provides a standard warranty period of 60 months (5 years) from the invoice date;
2. The customer fails to provide the invoice: from the production date (according to the SN number of the machine), Our company provides a warranty period of 63 months (5.25 years).
3. Other pv components GPRS, WIFI, warranty period of 5 years;Lightning protection is guaranteed for 3 years. Damage caused by lightning is not covered by the warranty.
4. In case of any special warranty agreement, the purchase agreement shall prevail.

Extended warranty period

Within 12 months of the purchase of the inverter (based on the purchase invoice) or within 24 months of the production of the inverter(SN number of machine, based on the first date of arrival),Customers can apply to buy extended warranty products from the company's sales team by providing the product serial number, Our company may refuse to do not conform to the time limit extended warranty purchase application.Customers can buy an extended warranty of 5, 10, 15 years.

If the customer wants to apply for the extended warranty service, please contact the sales team of our company. to purchase the products that are beyond the purchase period of extended warranty but have not yet passed the standard quality warranty period. Customers shall bear different extended premium.

During the extended warranty period, pv components GPRS, WIFI and lightning protection devices are not included in the extended warranty period. If they fail during the extended warranty period, customers need to purchase and replace them from the our company.

Once the extended warranty service is purchased, our company will issue the extended warranty card to the customer to confirm the extended warranty period.

Invalid warranty clause

Equipment failure caused by the following reasons is not covered by the warranty:

- 1)The "warranty card" has not been sent to the distributor or our company;
- 2) Without the consent of our company to change equipment or replace parts;
- 3) Use unqualified materials to support our company 's products, resulting in product failure
- 4) Technicians of non-company modify or attempt to repair and erase the product serial number or silk screen;
- 5) Incorrect installation, debugging and use methods;
- 6) Failure to comply with safety regulations (certification standards, etc.);
- 7) Damage caused by improper storage by dealers or end users;
- 8) Fransportation damage (including scratches caused by internal packaging during transportation).Please claim directly from the transportation company or insurance company as soon as possible and obtain damage identification such as container/package unloading;
- 9) Failure to follow the product user manual, installation manual and maintenance guidelines;
- 10) Improper use or misuse of the device;
- 11) Poor ventilation of the device;
- 12) The product maintenance process does not follow relevant standards;
- 13) Failure or damage caused by natural disasters or other force majeure (such as earthquake, lightning strike, fire, etc.).