



User manual

Energy storage integrated inverter

HYD 3000/3600/4000/4600/5000/6000-ES



CONTENT

1. HYD-ES inverter Introduction.....	1
2. Safety Notes.....	2
2.1. Safety Notes.....	2
2.2. Installation and Maintenance Notes.....	2
2.3. Signs on the inverter.....	3
3. Installation.....	5
3.1. Product Overview.....	5
3.2. Packing List.....	6
3.3. Installation Environment.....	6
3.4. Installation Tools.....	7
3.5. Installation Position.....	8
3.6. Mount HYD-ES inverter.....	8
4. Electrical Connection.....	10
4.1. Battery Connection.....	11
4.2. PV Connection.....	11
4.3. Inverter logic interface connection.....	13
4.4. CT / CAN / RS485 / NTC connection.....	15
4.5. Grid Connection.....	17
4.6. Critical Load Connection (EPS function).....	18
4.7. WiFi/GPRS/Ethernet module installation procedure.....	19
5. Buttons and indicator lights.....	20
5.1. Buttons.....	20
5.2. Indicator lights and status of HYD-ES inverter.....	20
6. Operation.....	21
6.1. Double Check.....	21
6.2. First Time Setup (IMPORTANT!).....	21
6.3. Commissioning.....	24
6.4. Menu.....	24
6.4.1. Basic setting.....	25
6.4.2. Advanced setting.....	30
6.4.3. Event List.....	33
6.4.4. System information interface.....	33
6.4.5. Energy Statistic.....	34
6.4.6. Software upgrade.....	35
7. Troubleshooting.....	37
Maintenance.....	42
8. Technical Data.....	43
9. Quality Assurance.....	46

1. HYD-ES inverter Introduction

The HYD-ES hybrid inverter is used in PV system with battery storage.

Energy produced by the PV system will be optimized for maximum self-consumption.

The HYD-ES inverter can work in auto or time-of-use (TOU) mode, charge / discharge the battery when needed. In auto mode, the HYD-ES inverter will charge surplus PV energy into the battery & discharge battery to supply power to local load when PV energy is not enough.

In case of blackout, HYD-ES inverter can work in Emergency Power Supply (EPS) mode. HYD-ES inverter will utilize power from PV panels & energy stored in the battery to supply power to critical load.



Fig. 1 HYD-ES inverter schematic diagram

2. Safety Notes

Before installation, please make sure you read & understand this manual. The HYD-ES inverter strictly comply with safety rules of design and testing. During the installation, operation and maintenance, operators should abide by local safety regulations. Improper operation may cause an electric shock or damage the equipment and properties.

2.1. Safety Notes

- ✧ Electrical installation and maintenance must be carried out by competent electricians according to local regulations.
- ✧ HYD-ES inverter can only be installed by qualified electrician, and only those who have appropriate accreditation, as required by local authority.
- ✧ Do NOT put explosives or flammable materials, e.g. gasoline, kerosene, diesel, oil, wood slab, cotton, or rag close to batteries or HYD-ES inverter.
- ✧ Disconnect AC connection first, then disconnect battery & PV(PV1&PV2), then wait at least 5 minutes (discharge capacitors) before maintenance to prevent electric shock.
- ✧ HYD-ES inverter shall be disconnected completely (BAT, PV & AC) while being maintained.
- ✧ HYD-ES inverter can be very hot during working. Switch off HYD-ES inverter & wait HYD-ES inverter to cool down before maintenance.
- ✧ Keep children away from batteries & HYD-ES inverter.
- ✧ It's NOT allowed to open the front cover of HYD-ES inverter. This will void the product warranty.
- ✧ HYD-ES inverter damaged by improper installation/operation is NOT covered by the product warranty.







2.2. Installation and Maintenance Notes






- ✧ The battery has been charged more than 60% before being delivered and shall be prevented from short circuit during transportation and installation.
- ✧ HYD-ES inverter/batteries shall be placed in a well-ventilated place. Do not put the HYD-ES inverter/batteries in an airtight or badly ventilated place or cabinet. This can be very harmful to system performance & service life.
- ✧ Keep HYD-ES inverter/batteries away from direct sunshine. Don't put HYD-ES inverter/batteries close to a furnace or fire. The can lead battery to leak even explode.
- ✧ The current capacity of DC power cables (from battery to inverter) should be at least 90A. Use short DC power cables to avoid high voltage drop & power loss.
- ✧ Use a multimeter to check the batter voltage & polarity before switching ON batteries. Make sure connections are correct according to this manual.
- ✧ Use a multimeter to check the PV voltage & polarity before switching ON PV isolator. Make sure connections are correct according to this manual.
- ✧ If you want to store the batteries without using them, they should be disconnected from HYD-ES inverter, and be kept in a cool, dry, and ventilated environment.
- ✧ Battery maintenance operators shall have the knowledge and technical skill for battery maintenance;

- ✧ All batteries connected in parallel should be of the same model and have same firmware version. This is a design issue needs to be considered by designer/installer, particularly when replacing batteries or modifying an existing energy storage system.
- ✧ HYD-ES inverter is transformer-less, therefore the positive pole and negative pole of the PV array are NOT grounded. Otherwise it will cause inverter failure. In the PV system, all non-current carrying metal parts (such as: PV module frame, PV rack, combiner box enclosure, inverter enclosure) should be connected to earth.
- ✧ Warning: Do not disassemble or break the battery. Its electrolyte can be toxic and damage your skin and eyes.
- ✧ Warning: follow the following rules during battery installation/maintenance.
 - a) Take off your watch, ring, and other metal objects.
 - b) Only use tools with insulated handles.
 - c) Wear rubber gloves and shoes.
 - d) Do not put tools or metals above the battery.
 - e) Switch off HYD-ES inverter & batteries before connecting / disconnecting battery terminals.
 - f) Battery positive/negative poles should be isolated from ground.

2.3. Signs on the inverter

There are some symbols which are related to security on the inverter. Please read and understand the content of the symbols before system installation.


	<p>This symbol indicates a hazardous situation which could result in injuries, if not avoided.</p>
	<p>Risk of Electric Shock and wait at least 5 mins after switching OFF HYD-ES inverter.</p>
	<p>Be careful of high voltage and electric shock.</p>
	<p>Be careful of hot surface.</p>
	<p>Comply with the Conformity Europeanness (CE) certification.</p>
	<p>Earth terminal.</p>

	<p>Please read this manual before installing HYD-ES inverter.</p>
	<p>This indicates the degree of protection of the equipment according to IEC standard 70-1 (EN 60529 June 1997).</p>
	<p>Positive pole and negative pole of the DC voltage (PV & Battery).</p>
	<p>This side up, HYD-ES inverter must always be transported, handled and stored in such a way that the arrows always point upwards.</p>
	<p>RCM (Regulatory Compliance Mark) The product complies with the requirements of the applicable Australian standards.</p>

3. Installation

3.1. Product Overview

HYD-ES inverter is 100% strictly inspected before package and delivery. It is forbidden to put the HYD-ES inverter upside down during delivery.

	CAUTION
	Please check the product package and fittings carefully before installation.

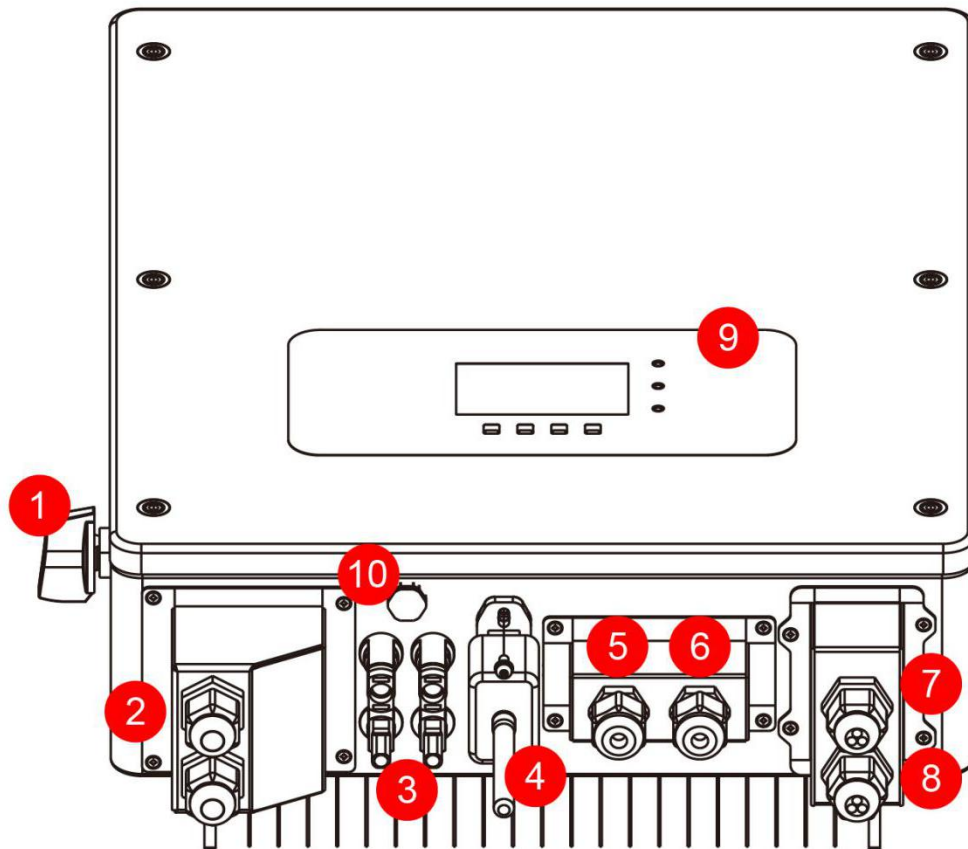


Fig. 2 HYD-ES inverter overview

1	DC switch	6	Current transformer port
2	Battery input terminals	7	Load connection port
3	PV input terminals	8	Grid connection port
4	Wi-Fi/GPRS stick	9	LCD
5	BMS communication port	10	breather valve

3.2. Packing List

Inspect the package and fittings carefully before installation. You should have the following fittings:

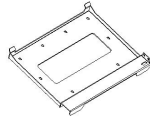






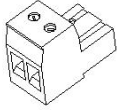
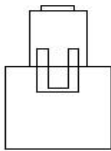



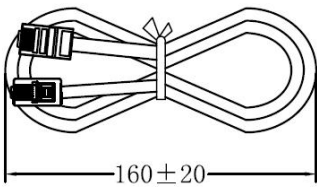


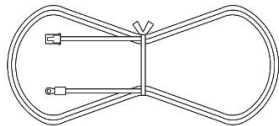
 Mounting Bracket × 1	 AC terminal × 6	 M5 screw × 2	 Battery terminal × 2
 M6 flat washer × 8	 Expansion Bolts × 8	 Terminal cap × 4	 CT terminal × 2
 Current Transformer × 1	 User Manual × 1	 Warranty card × 1	 Quality Certificate × 1
 Communication cable × 1	 PV+ input terminal × 2	 PV- input terminal × 2	 NTC × 1 (Long-3M)

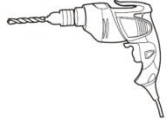

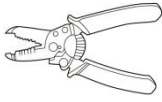

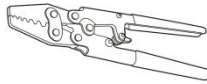
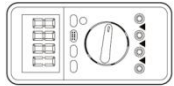


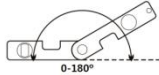
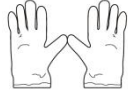


Fig. 3 Accessories of HYD-ES inverter

3.3. Installation Environment

- ✧ Choose a dry, clean, and tidy place, convenient for installation
- ✧ Ambient temperature range: $-25^{\circ}\text{C} \sim 60^{\circ}\text{C}$
- ✧ Relative humidity: $0 \sim 100\%$ (non-condensed)
- ✧ HYD-ES inverter shall be installed in a well-ventilated place
- ✧ No flammable or explosive materials close to HYD-ES inverter
- ✧ The AC overvoltage category of HYD-ES inverter is category III
- ✧ Maximum altitude: 2000m

3.4. Installation Tools

The following tools shall be prepared before installation:

No.	Tool	Model	Function
1		Hammer drill Recommend drill dia.6mm	Used to drill holes on the wall
2		Screwdriver	wiring
3		Wire stripper	Strip wire
4		4mm Allen Key	Turn the screw to connect rear panel with inverter
5		Crimping tools	Used to crimp power cables
6		Multi-meter	Used to check grounding
7		Marker pen	Used to mark signs
8		Measuring tape	Used to measure distances
9		Level	Used to ensure that the rear panel is properly installed
10		ESD gloves	Operators wear
11		Safety goggles	Operators wear
12		Anti-dust respirator	Operators wear

3.5. Installation Position

HYD-ES inverter should be vertically mounted (to ensure fast heat dissipation), please choose a position without direct sunlight / snow accumulation to install HYD-ES inverter. Please the installation position is well-ventilated.

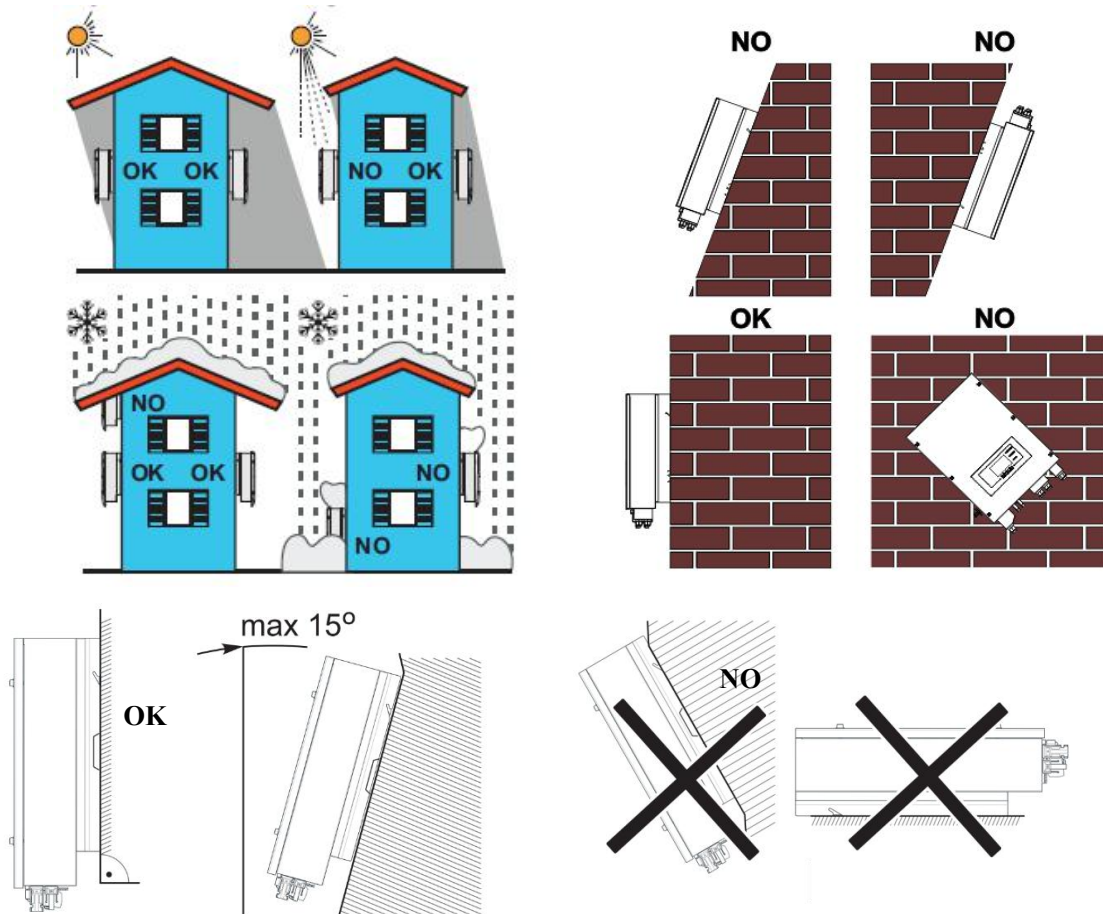


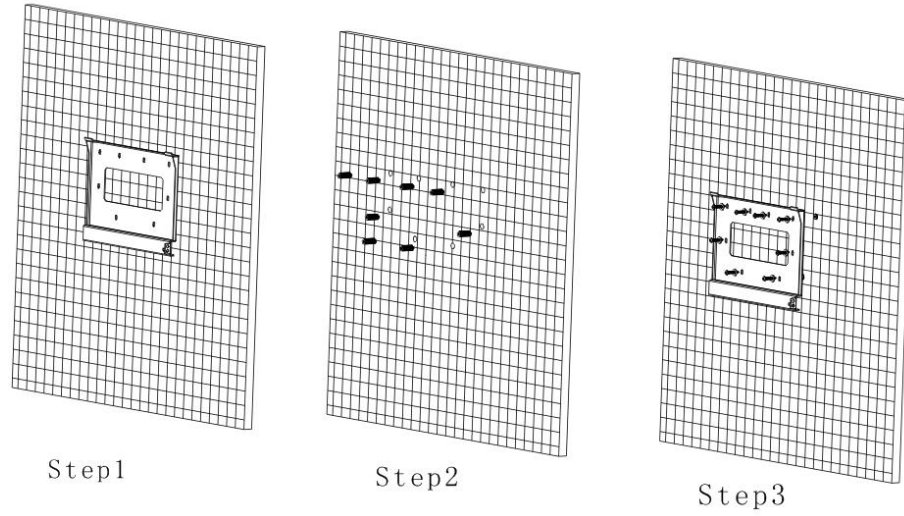
Fig. 4 Installation Position of HYD-ES inverter

3.6. Mount HYD-ES inverter

Step 1: Put the mounting bracket properly on the wall, mark these 8 drill holes using a marker pen. Drill 8 holes (drill bit 6mm) on the wall.

Step 2: Insert the expansion screw vertically into the hole, note the insertion depth. (not too shallow or too deep)

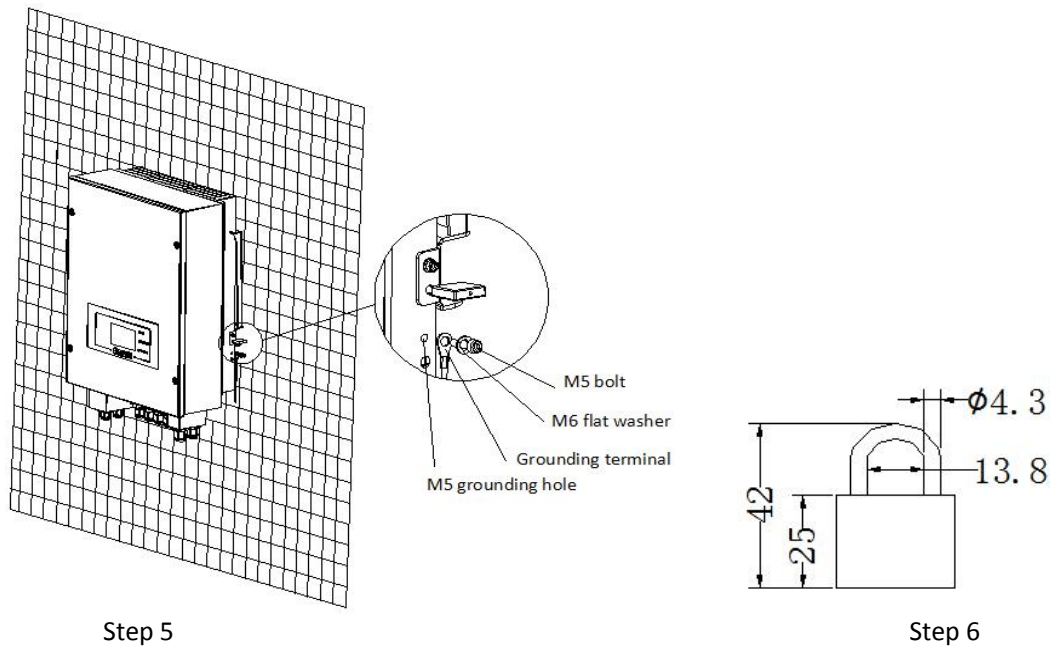
Step 3: Fix the mounting bracket on the wall using bolts & flat washers.





Step 4: Put HYD-ES inverter on the mounting bracket.

Step 5: Earth HYD-ES inverter using the grounding hole on the heat sink.

Step 6: OPTIONAL: you can lock HYD-ES inverter to the mounting bracket.



4. Electrical Connection

	CAUTION
	<p>High voltages in power conversion circuits. Lethal hazard of electric shock or serious burns.</p> <p>All work on the PV modules, inverters, and battery systems must be carried out by qualified personnel only.</p> <p>Wear rubber gloves and protective clothing (protective glasses and boots) when working on high voltage/high current systems such as INVERTER and battery systems.</p>
	CAUTION
	<p>HYD-ES inverter is intended to be used in PV system with battery storage. If not used as intended, the protection provided by the equipment may be impaired.</p>

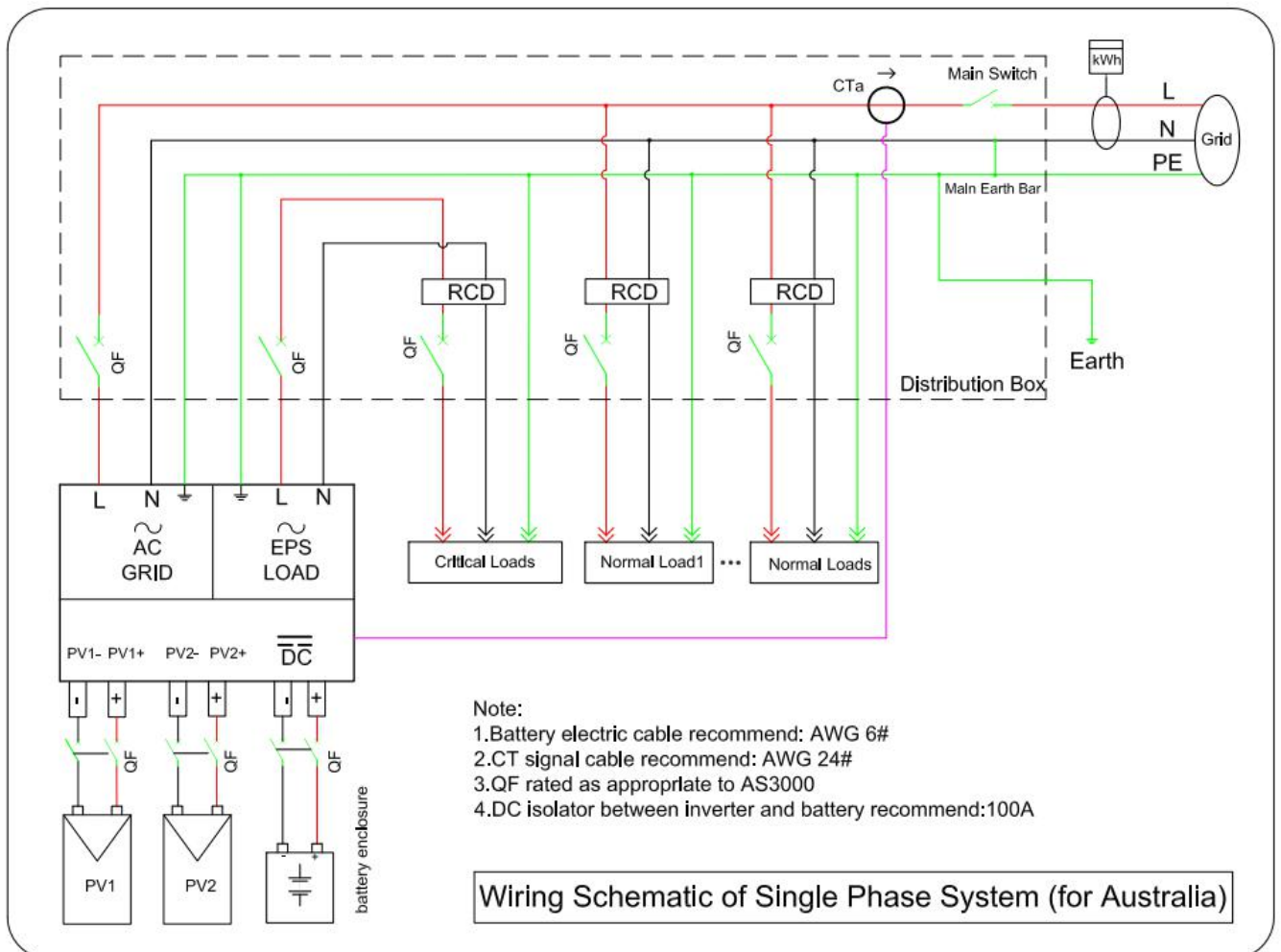


Fig. 5 Electrical connections

4.1. Battery Connection

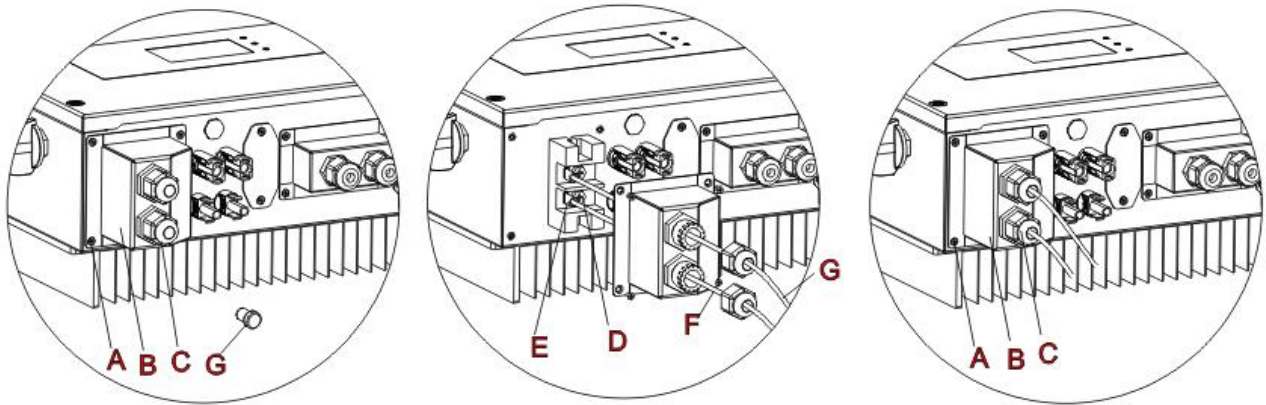


Fig. 6 Battery connection (Measure battery wires polarity/voltage before connection)

Step 1: Loosen 4 screws (A) using a screwdriver (Fig. 6);

Step 2: Remove the waterproof cover (B), loosen the cable gland (C), and then remove the stopper (G);

Step 3: Route the battery wires (F) through the cable gland, then connect battery wires using OT terminal (E);

Step 4: Fasten the waterproof cover using 4 screws.

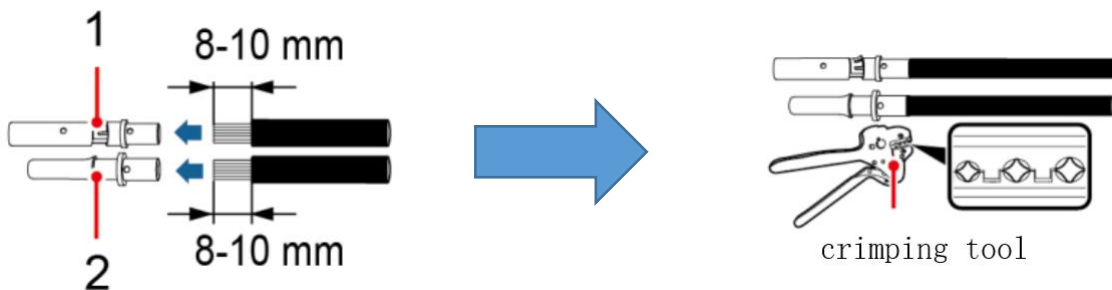
4.2. PV Connection

Recommended DC input cable specifications

Cross-Sectional Area (mm ²)		External Cable Diameter(mm ²)
Range	Recommended Value	
4.0~6.0	4.0	4.5~7.8

Procedure:

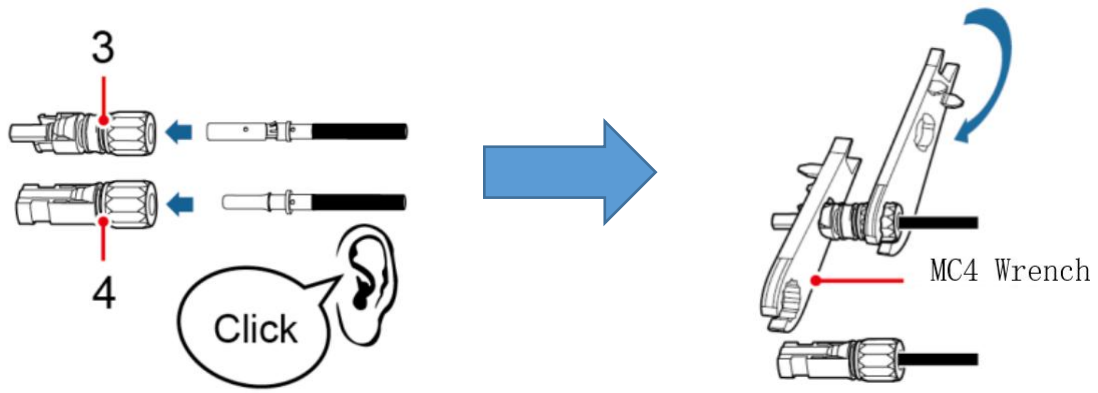
Step 1 Prepare PV positive and negative power cables



1. Positive metal contact 2. Negative metal contact

Fig. 7 prepare PV positive and negative power cables

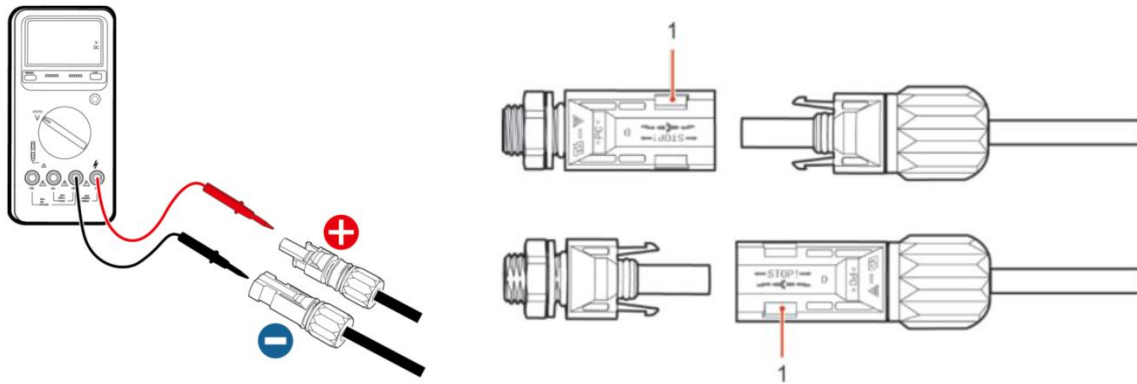
Step 2 Insert crimped PV positive and negative power cables into corresponding PV connectors



3. Positive connector 4. Negative connector

Fig. 8 prepare PV positive and negative connectors

Step 3 Make sure the DC voltage of each PV string is less than 600V DC and polarities of PV power cables are correct. Insert the positive and negative connectors into HYD-ES inverter until you hear a "click" sound, as shown in Fig. 9.



1. Bayonet

Fig. 9 Connect PV connectors

	CAUTION
	Before removing the PV positive and negative connectors, ensure that the DC SWITCH is OFF.

Follow-up Procedure

Use a MC4 wrench to disconnect PV connectors, as shown in Fig. 10.

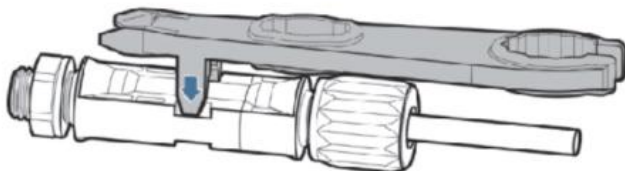


Fig. 10 Disconnect PV connectors

4.3. Inverter logic interface connection

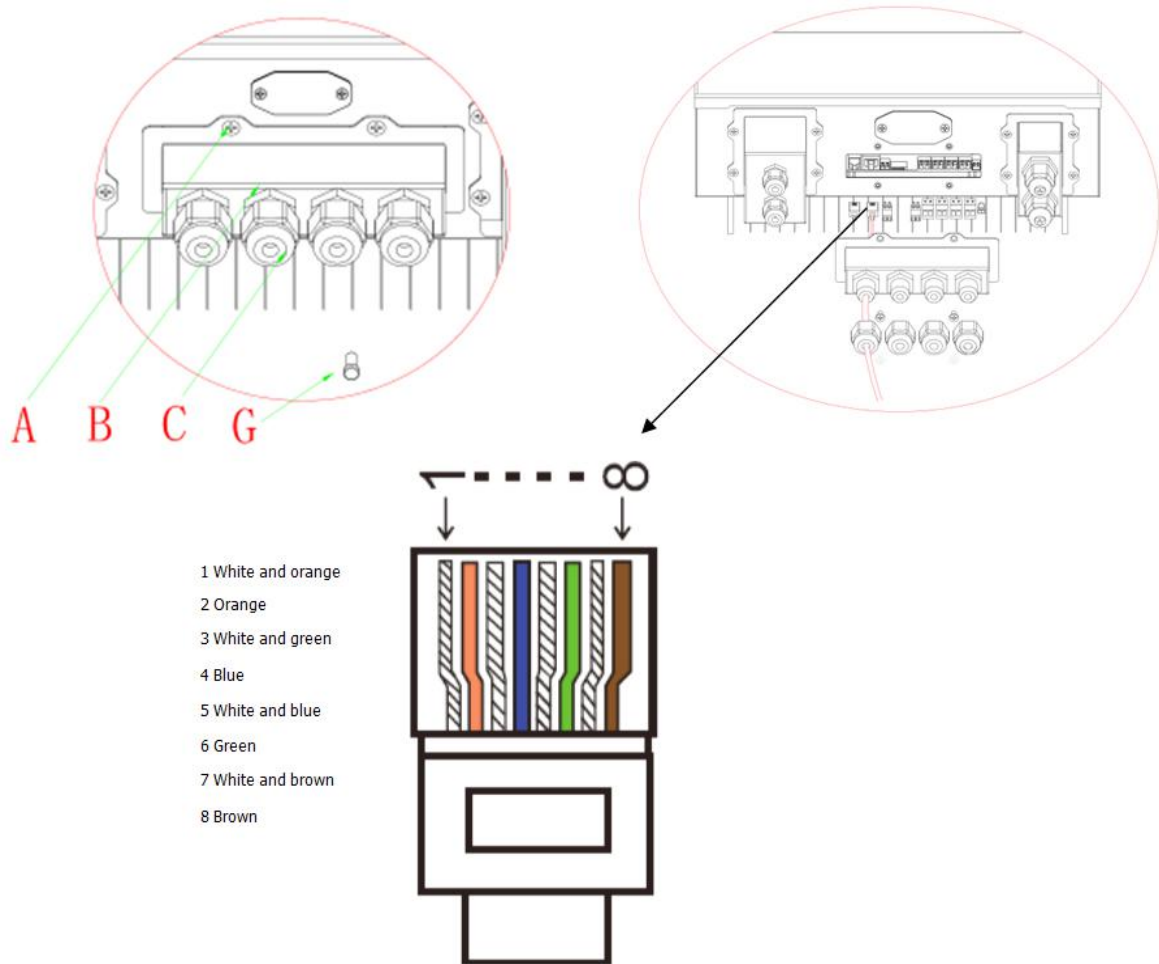


Fig. 11 Inverter logic interface connection

Step 1: Loosen 4 screws (A) using a screwdriver (fig. 11);

Step 2: Remove the waterproof cover (B), Loosen the cable gland (C), and then remove the stopper (G);

Step 3: Press the wire terminals in color sequence;

Step 4: Route Cable terminal through the cable gland, Insert the communication cable into the RJ45 connector;

Step 5: Fasten the waterproof cover using 4 screws.

The logic interface pin definitions and circuit connections are as follows:

Logic interface pin are defined according to different standard requirements

(a) Logic interface for AS/NZS 4777.2:2015, also known as inverter demand response modes (DRMs).

The inverter will detect and initiate a response to all supported demand response commands within 2 s.

The inverter will continue to respond while the mode remains asserted.

Table 4-1 Function description of the DRMs terminal

Pin NO.	Color	Function
1	White and orange	DRM1/5
2	Orange	DRM2/6
3	White and green	DRM3/7
4	Blue	DRM4/8

5	White and blue	DRM0
6	Green	RefGen
7	White and brown	Pin7&Pin8 short internal
8	Brown	

(b) Logic interface for VDE-AR-N 4105:2018-11, is in order to control and/or limit the inverter’s output power. The inverter can be connected to a RRCR (Radio Ripple Control Receiver) in order to dynamically limit the output power of all the inverters in the installation.

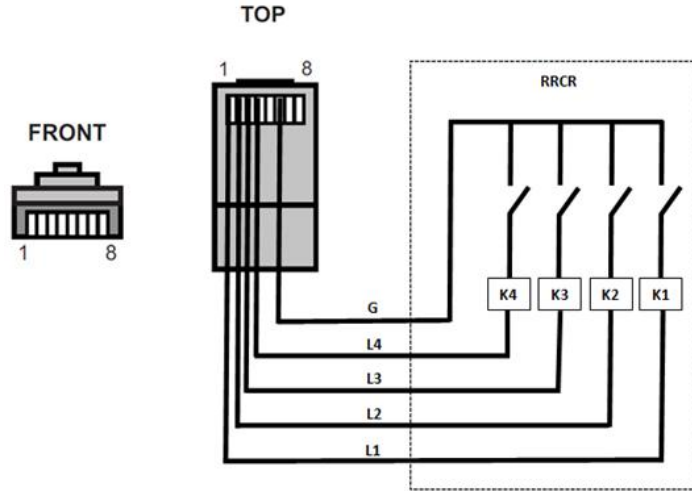


Fig.12 Inverter – RRCR Connection

Function description of the terminal

Pin NO.	Pin name	Description	Connected to (RRCR)
1	L1	Relay contact 1 input	K1 - Relay 1 output
2	L2	Relay contact 2 input	K2 - Relay 2 output
3	L3	Relay contact 3 input	K3 - Relay 3 output
4	L4	Relay contact 4 input	K4 - Relay 4 output
5	NC	Not Connected	Not Connected
6	G	GND	Relays common node
7	NC	Not Connected	Not Connected
8	NC	Not Connected	Not Connected

The inverter is preconfigured to the following RRCR power levels

Relay status: close is 1, open is 0

L1	L2	L3	L4	Active Power	Cos(φ)
1	0	0	0	0%	1
0	1	0	0	30%	1
0	0	1	0	60%	1
0	0	0	1	100%	1

(c) Logic interface for EN50549-1:2019, is in order to cease active power output within five

seconds following an instruction being received at the input interface.

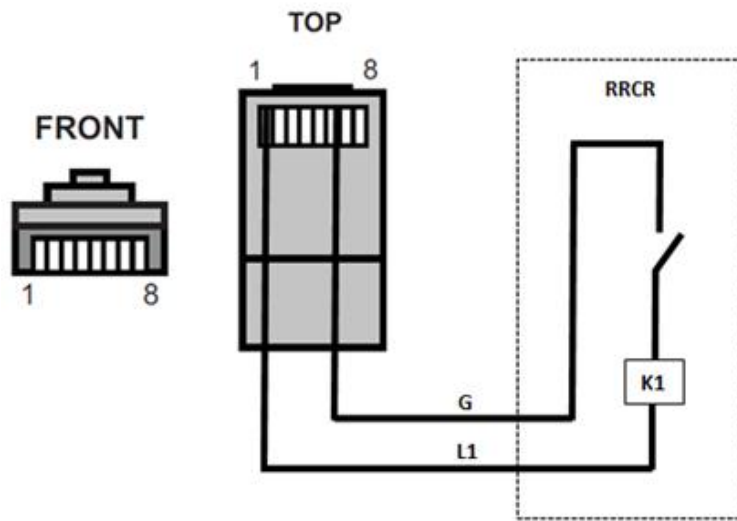


Fig.13 Inverter – RRCR Connection

Table 4-4 Function description of the terminal

Pin NO.	Pin name	Description	Connected to (RRCR)
1	L1	Relay contact 1 input	K1 - Relay 1 output
2	NC	Not Connected	Not Connected
3	NC	Not Connected	Not Connected
4	NC	Not Connected	Not Connected
5	NC	Not Connected	Not Connected
6	G	GND	K1 - Relay 1 output
7	NC	Not Connected	Not Connected
8	NC	Not Connected	Not Connected

Table 4-5 The inverter is preconfigured to the following RRCR power levels

Relay status: close is 1, open is 0

L1	Active Power	Power drop rate	Cos(ϕ)
1	0%	< 5 seconds	1
0	100%	/	1

4.4. CT / CAN / RS485 / NTC connection

CT (Current transformer) can measure the value and direction of AC current. Refer to Fig. 14 for the correct connection of CTa.

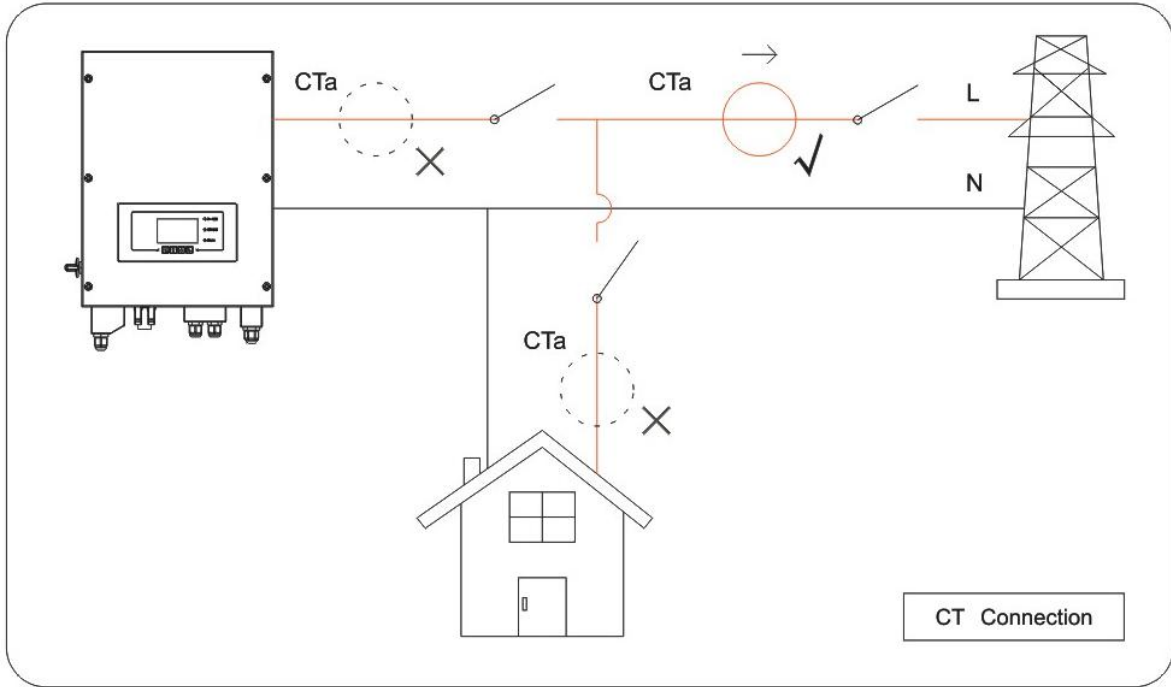


Fig. 14 CTa connection

Step 1: Refer to Fig. 11 for correct position of CTa. Wrap the CT around L wire of incoming mains, make sure that the CT arrow direction is “home → grid”.

Step 2: You can use network cable & terminal caps to extend CT wires if necessary, the maximum CT cable length is 200m.

CT wire	Extension cable (network cable)	HYD-ES inverter
Red	Orange / white orange / brown / white brown	CT+
Black	Green / white green / blue / white blue	CT-

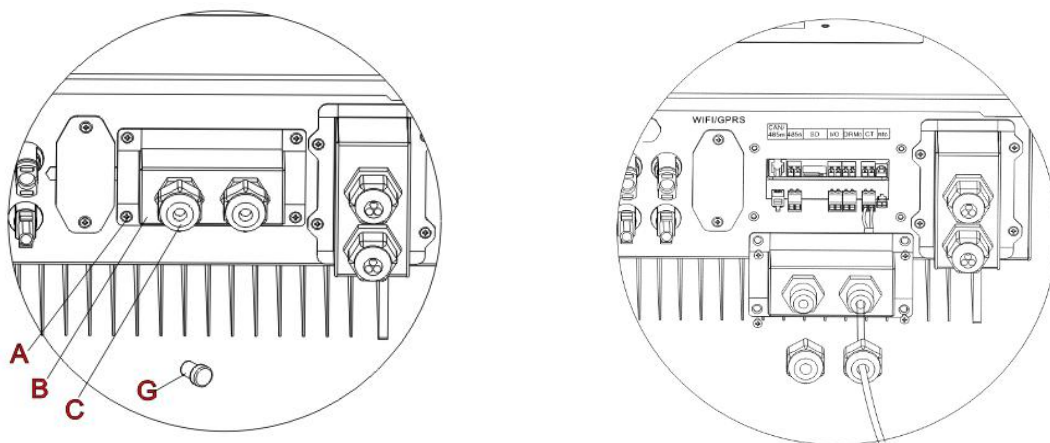


Fig. 15 CT / CAN / RS485 / NTC connection



Step 3: Loosen 4 screws (part A) using a screwdriver (Fig. 15)

Step 4: Remove the waterproof cover (part B), loosen the cable gland (part C), then remove the stopper (part G)

Step 5: Route CT cable through the cable gland, connect CT cable to CT terminal, then insert CT terminal into corresponding ports.

Step 6: One communication cable (between battery BMS & HYD-ES inverter) is provided in the HYD-ES inverter accessory bag. One inverter end, one BAT end.

Route the communication cable (inverter end) through the cable gland, insert the 4P4C connector to HYD3000/4000/5000/6000-ES CAN port. Insert the 8P8C connector (BAT end) to PYLONTECH battery CAN port.

Communication cable between battery & HYD-ES inverter	CAN communication	
	HYD-ES inverter	
	CAN port	CANH---pin1 CANL---pin2
	RS485 port	485A----pin3 485B----pin4
	PYLONTECH US2000 PLUS / US3000 AMASS Battery	
	CAN Port	CANH---pin4 CANL---pin5
	RS485 port	485A----pin2 & pin7 485B----pin1 & pin8

Step 7: Connect NTC for lead acid batteries only:

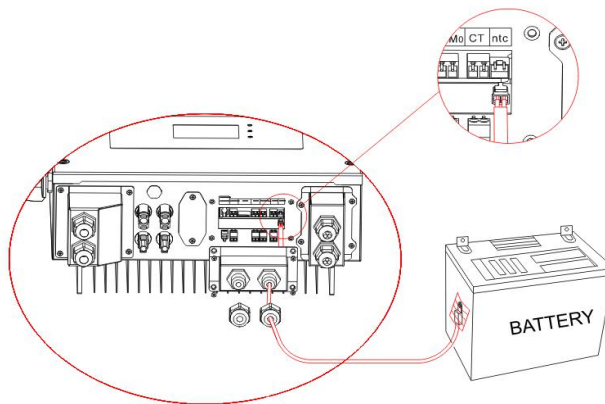


Fig. 16 NTC connection

Step 8: Fasten the waterproof cover using 4 screws.

4.5. Grid Connection

Step 1: Loosen 4 screws (part A) using a screwdriver (fig. 17)

Step 2: Remove the waterproof cover (part B), loosen the cable gland (part C), then remove the stopper (part G)

Step 3: Route a 3-core cable through GRID cable gland, then connect 3 wires to corresponding terminal blocks. (BROWN – L, BLUE – N, YELLOW/GREEN – PE)

Step 4: Fasten the waterproof cover using 4 screws.

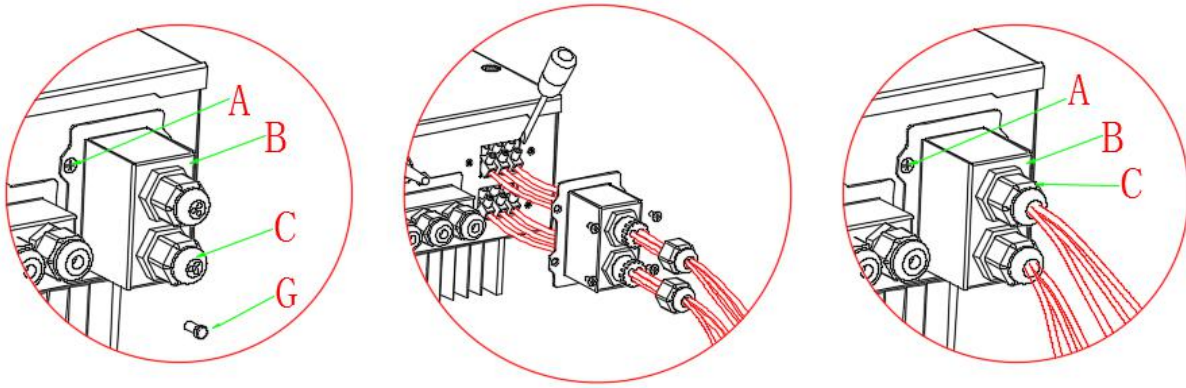


Fig. 17 Grid & Load connection

Context

All the AC output cables used for the inverters are outdoor three-core cables. To facilitate the installation, use flexible cables. The following table lists the recommended specifications for the Breaker.

Model	HYD 3000-ES	HYD 3600-ES	HYD 4000-ES	HYD 4600-ES	HYD 5000-ES	HYD 6000-ES
Breaker	25A	25A	32A	32A	32A	32A


4.6. Critical Load Connection (EPS function)

Critical load: in case of grid outage, if EPS function is enabled, HYD-ES inverter will work in EPS (Emergency Power Supply) mode, utilize the PV power & energy stored in the battery to supply power to critical load via LOAD connection port.

LOAD connection port is only for critical load connection. The power of critical loads must be less than 3000VA.

The connection procedure of LOAD port is the same as grid connection (Fig. 18).

Change-over positions

	CAUTION
	<p>The changeover switch is necessary.</p> <p>While checking/repairing critical load, make sure change-over switch is at position 0.</p> <p>While checking/repairing HYD-ES inverter, make sure change-over switch is at position 0 & HYD-ES inverter is disconnected from grid.</p>

- ✧ Under normal conditions: change-over switch is at position 1. HYD-ES inverter can supply power to critical load in case of blackout.
- ✧ If the HYD-ES inverter is faulty, manually change the switch to position 2. Grid will supply power to critical load.

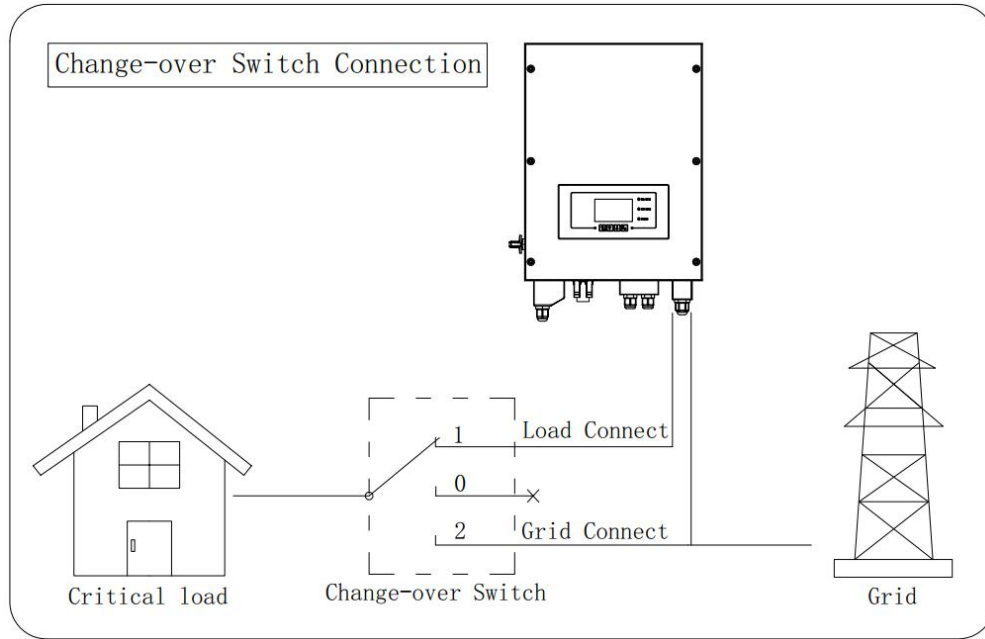


Fig. 18 Change-over Switch connections

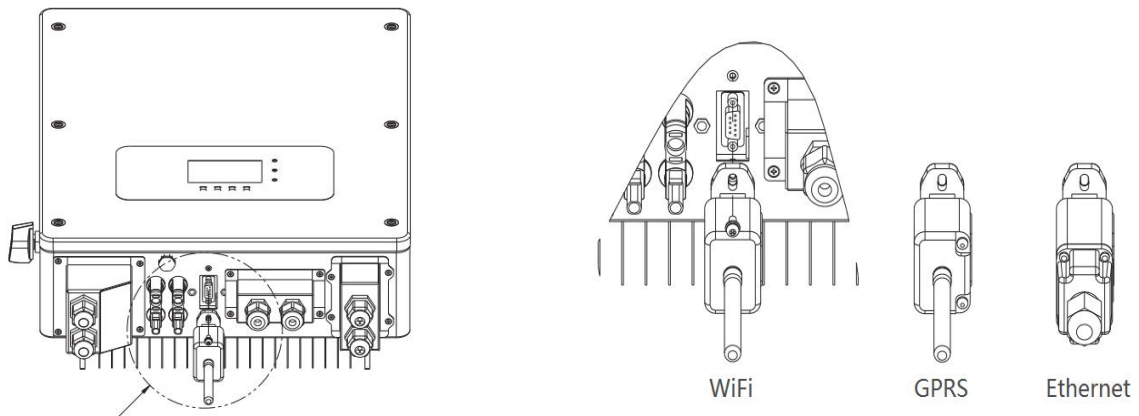
4.7. WiFi/GPRS/Ethernet module installation procedure

NOTE:GPRS and Ethernet is optional and is not suitable for all countries .

Step1: Remove WiFi/GPRS/Ethernet waterproof cover using screw driver.

Step2: Install WiFi/GPRS/Ethernet module.

Step3: Fasten WiFi/GPRS/Ethernet module using screws.



The operation information (generated energy, alert, operation status) of the inverter can be transferred to PC or uploaded to the server via WiFi /GPRS/ Ethernet. You can register on the website.

http://www.solarmanpv.com/portal/Register/Regi_Pub.aspx

Using the WiFi/GPRS/Ethernet S/N number(NOTE3), then you can login the website:

<http://www.solarmanpv.com/portal/LoginPage.aspx> to remote monitors the inverter.

Note1:S/N number of the WiFi/GPRS/Ethernet module is located on the side.

Note2:Specific use methods of WiFi/GPRS/Ethernet can refer to the operation manual of WiFi/GPRS/Ethernet.

5. Buttons and indicator lights

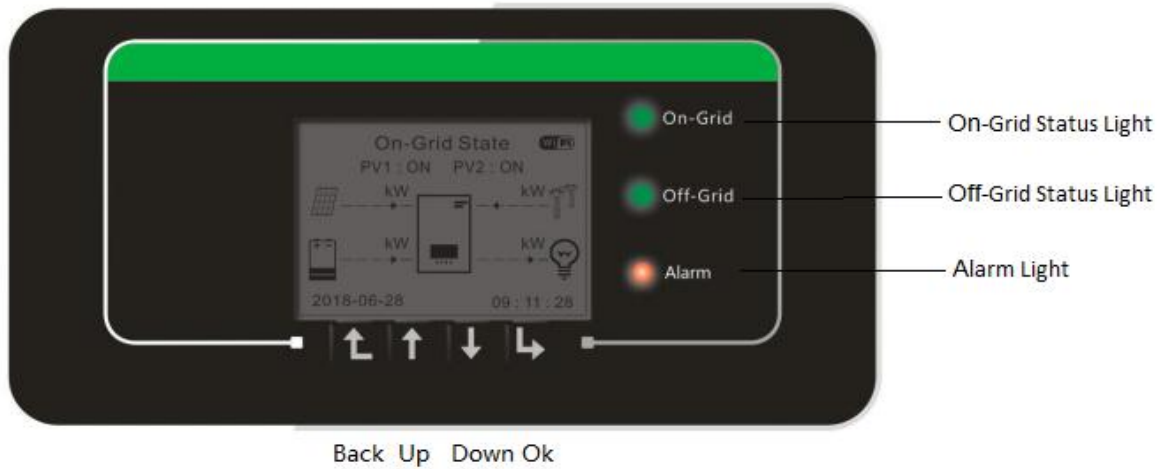


Fig 19. Buttons and indicator lights

5.1. Buttons

- ✧ press “Back” to the previous screen or enter the main interface.
- ✧ press “Up” to the upper menu option or value plus 1.
- ✧ press “Down” to the lower menu option or value minus 1.
- ✧ Press “OK” to select the current menu option or switch to the next digit.

5.2. Indicator lights and status of HYD-ES inverter

Status of HYD inverter	On Grid Green light	Off-Grid Green light	Alarm Red light
On-grid	ON		
Standby (On-Grid)	Flashing		
Off-Grid		ON	
Standby (Off-Grid)		Flashing	
Alarm			ON

6. Operation

6.1. Double Check

Please double check the following before operation.

1. HYD-ES inverter is firmly fastened to the mounting bracket on the wall;
2. PV+/PV- wires are firmly connected, polarity and voltage are correct;
3. BAT+/BAT- wires are firmly connected, polarity and voltage are correct;
4. DC isolator is correctly connected between battery & HYD-ES inverter, DC isolator: OFF;
5. GRID / LOAD cables are firmly / correctly connected;
6. AC circuit breaker is correctly connected between HYD-ES inverter GRID port & GRID, circuit breaker: OFF;
7. AC circuit breaker is correctly connected between HYD-ES inverter LOAD port & critical load, circuit breaker: OFF;
8. For lithium battery, please ensure that the communication cable has been correctly connected;
9. For the lead-acid battery, please ensure that the NTC wire has been correctly connected.

6.2. First Time Setup (IMPORTANT!)

IMPORTANT: PLEASE FOLLOW THE FOLLOWING PROCEDURE to switch ON HYD-ES inverter

1. Make sure there's no power generation in HYD-ES inverter's phase.
2. Turn ON DC switch.
3. Switch ON the battery. Turn ON DC isolator between battery & HYD-ES inverter.
4. Turn ON AC circuit breaker between the HYD-ES inverter GRID port & GRID.
5. Turn ON AC circuit breaker between the HYD-ES inverter LOAD port & critical load.
6. HYD-ES inverter should start to operate now.

You need to set the following parameters before HYD-ES inverter starts to operate.

1)Set system time	8)*Set min discharge voltage
2)Set country	9)*Set max discharge current
3)Select battery type	10)*Set min protect voltage
4)*Set battery capacity	11)*Set discharge depth
5)*Set max charge voltage	12)*Set empty discharge voltage
6)*Set max charge current	13)*Set full charge voltage
7)*Set max protect voltage	

Note: 4)* to 13)* settings are only for DEFAULT battery type.


1)Set system time

System time format is “20YY-MM-DD-HH-MM-SS”, press “Up” or “Down” to change the 1st digit, press “OK” to switch to next digit, press “Ok” to complete setting. When system time setting is complete, “Set country” will pop up.

2)Set country

Press “Up” or “Down” to select a country, press “Ok” to complete the country setting. When country setting is complete, “Set battery type” will pop up.

Code	Country	Code	Country	Code	Country
00	Germany VDE4105	13	Germany BDEW	26	Philippines
01	CEI-021 Internal	14	Germany VDE0126	27	New Zealand
02	Australia	15	CEI-016 Italia	28	Brazil
03	SpainRD1699	16	UK G83/G98	29	Slovakia VSD
04	Turkey	17	Greece island	30	Slovakia SSE
05	Denmark	18	EU EN50438	31	Slovakia ZSD
06	Greece Continent	19	IEC EN61727	32	CEI0-21 In Areti
07	Netherland	20	Korea	37	Denmark TR322
08	Belgium	21	Sweden	39	Ireland EN50438
09	UK G59/G99	22	Europe General	40	Thailand PEA
10	China	23	CEI-021 External	44	South Africa
11	France	24	Cyprus		
12	Poland	25	India		

	CAUTION
	<p>It's very important to make sure that you have selected the correct country code according to requirements of local authority.</p> <p>Please consult qualified electrical engineer or personnel from electrical safety authorities about this.</p> <p>Shenzhen SOFARSOLAR Co., Ltd. is not responsible for any consequences arising out of incorrect country code selection.</p>

3)Select battery type

Press “Up” or “Down” to select your battery type, then press “Ok” to complete the battery type setting. If you're using “1. PYLON”, “2. DARFON”, “4. General Lithium”, “5. Alpha. ESS” or “6. SOLTARO” battery types, congratulations, inverter's first-time setup is complete. Please press “OK” to enter the main interface. But if you're using “3. DEFAULT” battery type. We need more information regarding your battery.

MENU	Compatible Batteries
1.PYLON	PYLONTECH US2000 PLUS / US2000B/US3000

	Note: Please confirm with representative of PYLONTECH that your battery is compatible with HYD3000/4000/5000/6000-ES
2. DARFON--NC	DARFON 14S31P ESS--NC
3.DEFAULT	LEAD ACID / LEAD CRYSTAL / AQUION battery
4. General Lithium	All batteries that comply with SOFAR'S BMS CAN communication protocol.
5. Alpha. ESS	M48112-P / SMILE-BAT
6. SOLTARO	SL-3KWH / SL-1KWH

4)*Set battery capacity (only for DEFAULT battery type)

Press "Up" or "Down" to change the 1st digit, press "OK" to switch to next digit. After changing the battery capacity per your battery specification, press "Ok", then "Set max charge voltage" will pop up.

5)*Set max charge voltage (only for DEFAULT battery type)

Press "Up" or "Down" to change the 1st digit, press "OK" to switch to next digit. After changing max charge voltage per your battery specification, press "Ok", then "Set max charge current" will pop up.

6)*Set max charge current (only for DEFAULT battery type)

Press "Up" or "Down" to change the 1st digit, press "OK" to switch to next digit. After changing the max charge current per your battery specification, press "Ok", then "Set max protect voltage" will pop up.

7)*Set max protect voltage (only for DEFAULT battery type)

Press "Up" or "Down" to change the 1st digit, press "OK" to switch to next digit. After changing the max protect voltage per your battery specification, press "Ok", then "Set min discharge voltage" will pop up.

8)*Set min discharge voltage (only for DEFAULT battery type)

Press "Up" or "Down" to change the 1st digit, press "OK" to switch to next digit. After changing the min discharge voltage per your battery specification, press "Ok", then "Set max discharge current" will pop up.

9)*Set max discharge current (only for DEFAULT battery type)

Press "Up" or "Down" to change the 1st digit, press "OK" to switch to next digit. After changing the max discharge current per your battery specification, press "Ok", then "Set min protect voltage" will pop up.

10)*Set min protect voltage (only for DEFAULT battery type)

Press "Up" or "Down" to change the 1st digit, press "OK" to switch to next digit. After changing the min protect voltage per your battery specification, press "Ok", then "Set discharge depth" will pop up.

11)*Set discharge depth (only for DEFAULT battery type)

Press "Up" or "Down" to change the 1st digit, press "OK" to switch to next digit. After changing the discharge depth per your battery specification, press "Ok", then "Set empty discharge voltage" will pop up.

12)*Set empty discharge voltage (only for DEFAULT battery type)

Press "Up" or "Down" to change the 1st digit, press "OK" to switch to next digit. After changing the empty discharge voltage per your battery specification, press "Ok", then "Set full charge voltage" will pop up.

13)*Set full charge voltage (only for DEFAULT battery type)

Press "Up" or "Down" to change the 1st digit, press "OK" to switch to next digit. After changing the full charge voltage per your battery specification, press "Ok".

Congratulations, HYD3000/4000/5000/6000-ES's first-time setup is complete. Please press "OK" to enter the main interface.

6.3. Commissioning

The main interface:

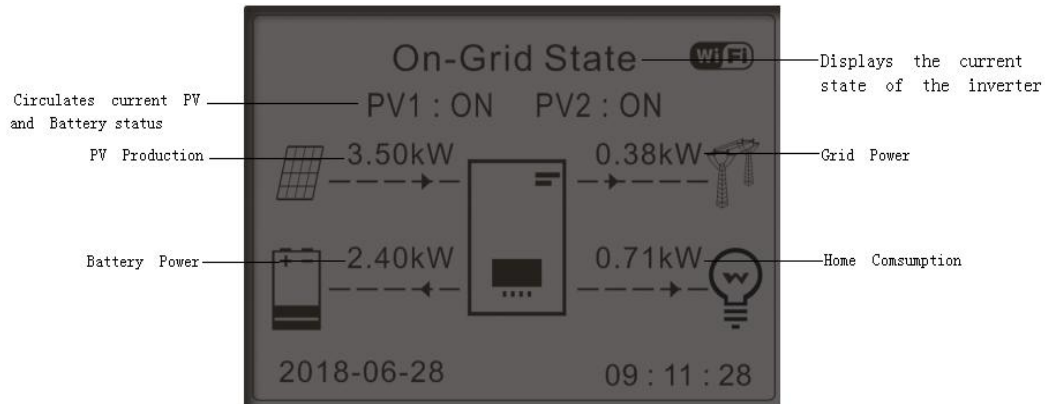


Fig 20. Main interface

If you didn't change the work mode of HYD-ES inverter, which means HYD-ES inverter is working in "Auto Mode":

While "PV Production" > "Home Consumption"

If the battery is not full. HYD-ES inverter will charge the battery.

While "PV Production" < "Home Consumption"

If the battery is not flat. HYD-ES inverter will discharge the battery.

6.4. Menu

In the main interface, press "Down" button to enter grid/battery parameters page:

Main Interface	Press "Down"
	1.Grid(V)
	2.AC Current(A)
	3.Frequency
	4.Batt(V)
	5.Batt Chrg Curr.
	6.Batt DisChrg Curr.
	7.State of Charge
	8.Batt Cycles
	9.Batt Temp.

In the main interface, press "UP" button to enter PV parameters page:

Main Interface	Press "UP"
	1.PV1 Voltage
	2.PV1 Current
	3.PV1 Power

4.PV2 Voltage
5.PV2 Current
6.PV2 Power
7.Inverter Temp.

In the main interface, press “back” button to enter main menu. The main menu has the following five options:

Main Interface	Press “Back”
“Up” ↑	1.Basic Setting
	2.Advanced Setting
	3.Event List
“Down” ↓	4.System Information
	5.Energy Statistic
	6.Software Update

6.4.1. Basic setting

1.Basic Setting	Press “OK”
Up” ↑	1.Language
	2.Time
	3.Energy Storage Mode
“Down” ↓	4.PV Input Mode
	5.EPS Mode
	6.Communication Addr.
	7.Auto Test

1. Set Language

Select “1. Language”, press “OK”. Press “up” or “down” to select the language and press “OK”.
Easier Way: press “Back” & “OK” at the same time to change system language.

2. Set Time

Select “2. Time”, press “OK” to enter time setting interface, system time format is 20YY-MM-DD HH:MM:SS
Press “Up” or “Down” to change the 1st digit, press “OK” to switch to next digit, after inputting the current time, press “OK”.

3. Energy Storage Mode

Select “3. Energy Storage Mode”, press “OK” to enter energy storage mode setting interface.

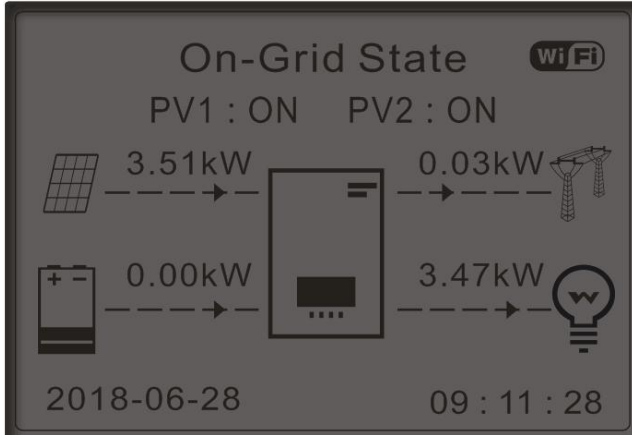
3.Energy Storage mode	
	1. Self-use Mode
	2. Time-of-use Mode
	3.Timing Mode
	4. Passive Mode

1) Set Self-use Mode

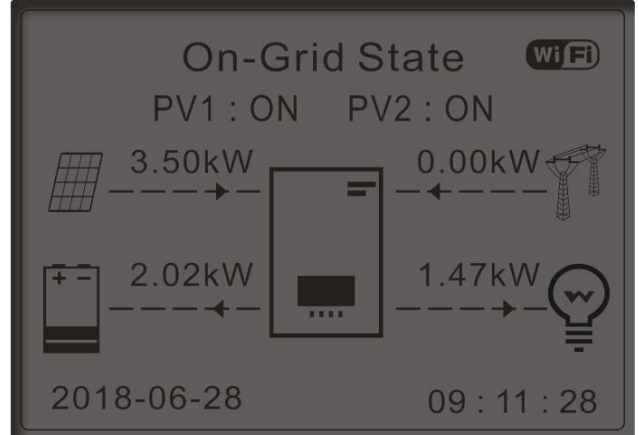
Select "1. Self-use Mode", then press "OK".

In Self-use mode, HYD-ES inverter will automatically charge & discharge the battery.

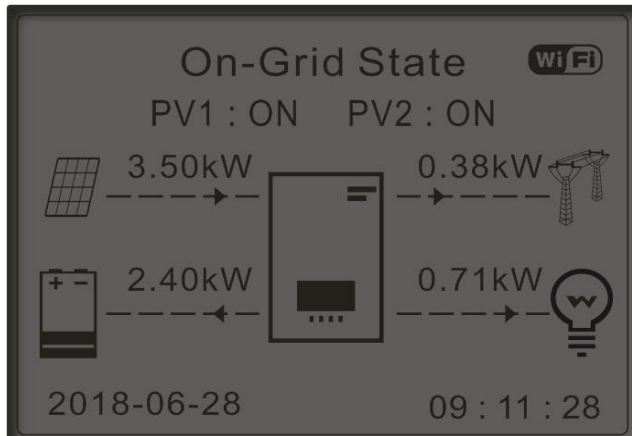
1) If PV generation = LOAD consumption ($\Delta P < 100W$) HYD-ES won't charge or discharge the battery.



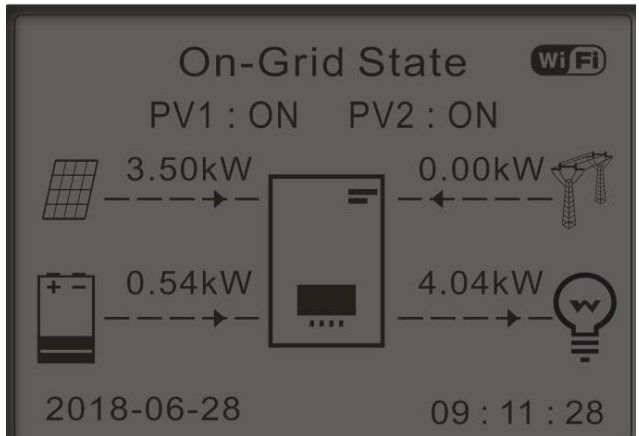
2) If PV generation > LOAD consumption, the surplus power will be stored in the battery.



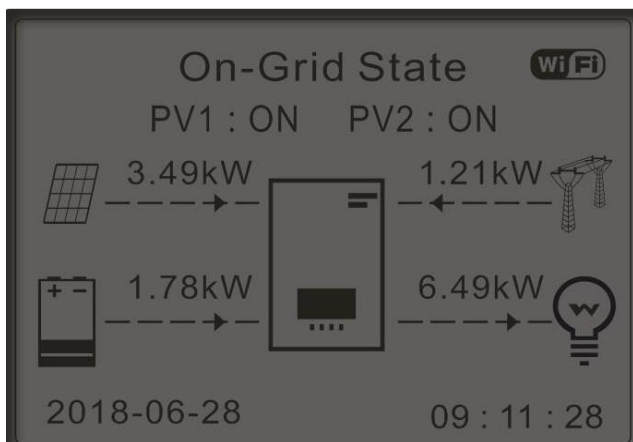
3) If the battery is full(or already at Max Charge Power), excess power will be exported to the grid.



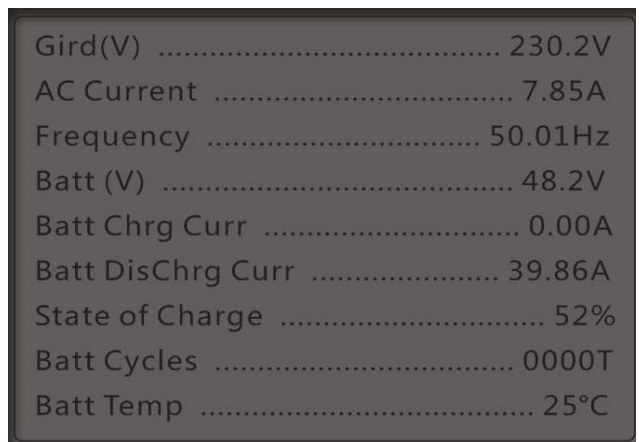
4) If PV generation < LOAD consumption, it will discharge the battery to supply power to load.



5) If PV generation + Battery < LOAD consumption, HYD-ES inverter will import power from the grid.



6) Press "DOWN" button to view current grid/battery parameters, press "UP" to get back to main interface.



2) Set Time-of-use Mode

Select "2. Time-of-use Mode", and then press "OK" to enter Set Time-of-use mode interface.

Set Time-of-use Mode			
Rules. 0: Enabled			
From	To	SOC	Charge
02h00m	- 04h00m	070%	1000W
Effective date			
Dec. 22 - Mar. 21			
Weekday select			
Mon. Tue. Wed. Thu. Fri. Sat. Sun.			

If electricity is more expensive in high demand time (peak rate) & electricity is much cheaper in low demand time (off-peak rate).

You can select an off-peak period to charge your battery. Outside the off-peak charge period, HYD-ES inverter is working in Auto Mode.

If your family normally go to work/school on weekdays & stay at home on weekends, which means the home electricity consumption is much higher on weekends. Thus, you need to store some cheap electricity on weekends only. This is possible using our Time-of-use mode.

In summer, if your PV system can produce more electricity than your home electricity consumption. Then you don't need to set an off-peak charge period to charge your battery in summer at all. You can select an effective date (normally winter) for Time-of-use mode in this case. Outside the effective date, HYD-ES inverter is working in Auto Mode.

You can set multiple Time-of-use rules to meet your more complex requirement. Right now we support 4 rules maximum (rule 0/1/2/3).

3) Set Timing Mode

Select "3. Timing Mode", and then press "OK" to enter Set Timing mode interface. The interface of Set Timing Mode is shown as below. You can select a charge time/power & discharge time/power in this mode.

Charge Start	22 h 00 m
Charge End	05 h 00 m
Charge Power	2000 W
DisCharge Start	14 h 00m
DisCharge End	16 h 00m
DisCharge Power	2500 W

Note: normally this mode is used to test whether HYD-ES inverter can charge & discharge correctly or not. So basically, this mode is used for testing purposes only.

4) Set Passive Mode

Select "4. Passive Mode", and then press "OK".

For more detailed information, please ask representative of SOFAR to get a copy of passive mode communication protocol.

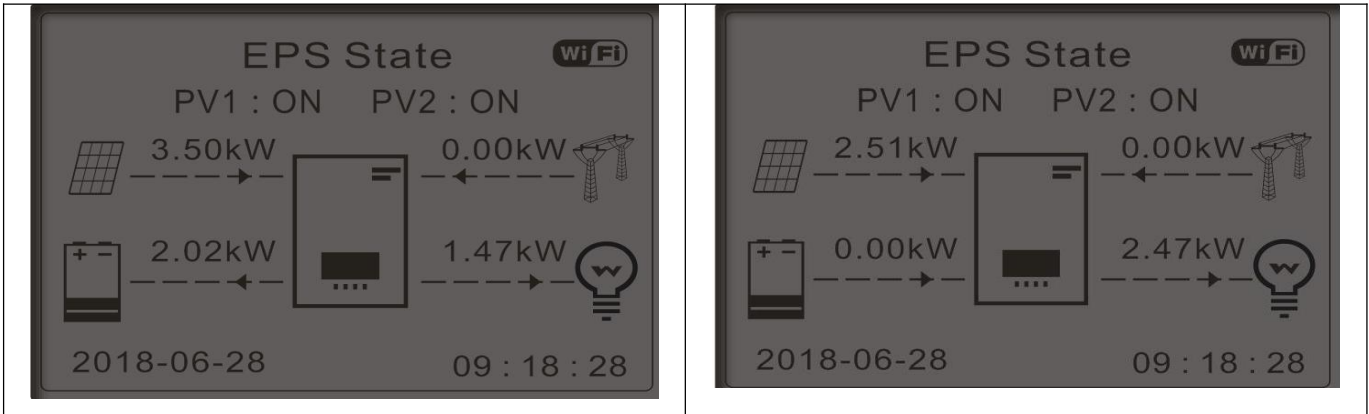
4. PV Input Mode

PV input mode selection: HYD-ES inverter has 2 MPPT channels. The 2 MPPT can operate independently, also can operate in parallel. If the PV strings are connected in parallel outside the inverter, you should choose the "in parallel mode", otherwise use the default setting (independent mode).

5. EPS Mode

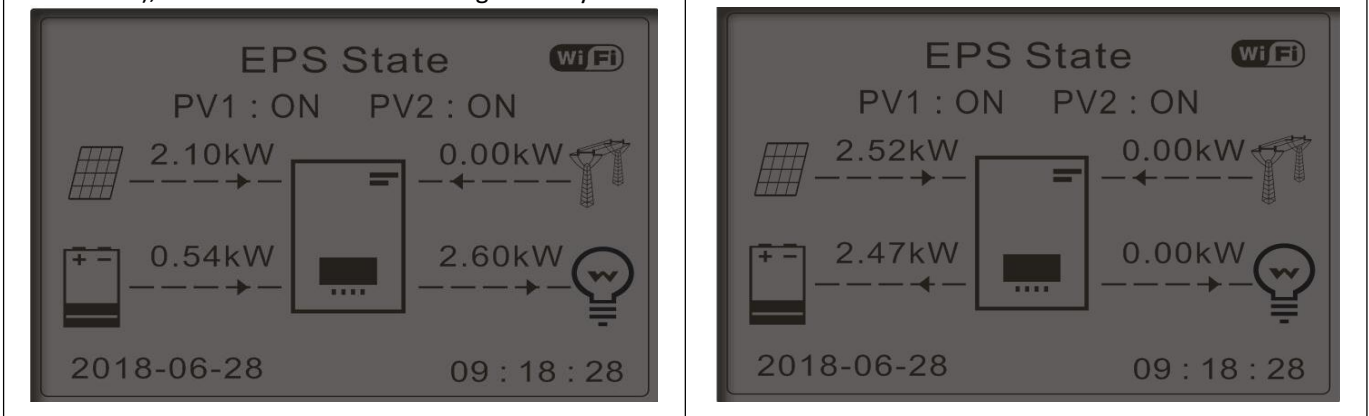
5. Set EPS Mode	1.EPS Mode Control	1.Enable EPS Mode
		2.Disable EPS Mode
	2.Set EPS Changeover Time (default 20ms)	***S()

1) If PV generation > LOAD consumption (Δ P > 100W), HYD-ES inverter will charge battery.	2) If PV generation = LOAD consumption, HYD-ES inverter wont' charge or discharge battery.
--	--



3) If PV generation < LOAD consumption ($\Delta P > 100W$), HYD-ES inverter will discharge battery.

4) If PV generation is normal, but LOAD consumption=0, the surplus power will be stored in the battery.



6. Communication Addr.

Select "6. Set Communication Addr.", press "OK". Press "Up" or "Down" to change the 1st digit, press "OK" to switch to next digit, after changing the 485-communication address (default :01), press "OK".

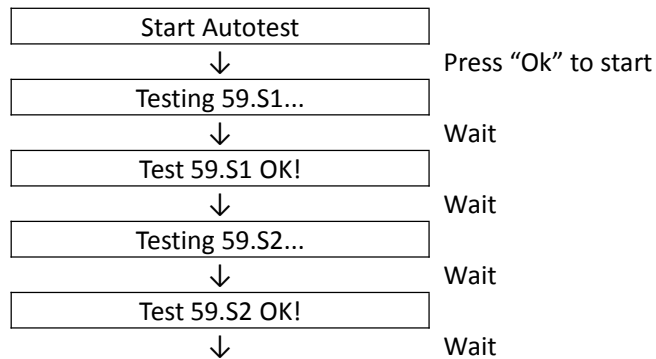
7. Auto Test (ONLY for Italian Market)

Select "7. Auto Test", press "OK" to enter autotest interface.

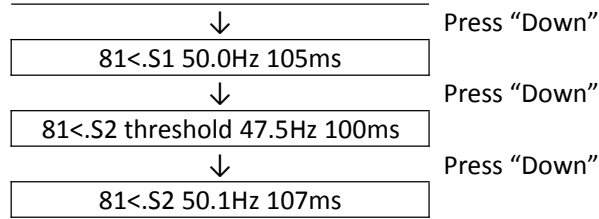
7.Auto Test	
	1.Autotest Fast
"Up" ↑	2.Autotest STD
	3.QF Time Setting
	4.QV Time Setting
"Down" ↓	5.Control 81.S1

1) Autotest Fast

Select "1. Autotest Fast", then press "OK" to start Auto test Fast.



Testing 27.S1...	
↓	Wait
Test 27.S1 OK!	
↓	Wait
Testing 27.S2...	
↓	Wait
Test 27.S2 OK!	
↓	Wait
Testing 81>S1...	
↓	Wait
Test 81>S1 OK!	
↓	Wait
Testing 81>S2...	
↓	Wait
Test 81>S2 OK!	
↓	Wait
Testing 81<S1...	
↓	Wait
Test 81<S1 OK!	
↓	Wait
Testing 81<S2...	
↓	Wait
Test 81<S2 OK!	
↓	Press "Ok"
Auto Test OK!	
↓	Press "Down"
59.S1 threshold 253V 900ms	
↓	Press "Down"
59.S1: 228V 902ms	
↓	Press "Down"
59.S2 threshold 264.5V 200ms	
↓	Press "Down"
59.S2: 229V 204ms	
↓	Press "Down"
27.S1 threshold 195.5V 400ms	
↓	Press "Down"
27.S1: 228V 408ms	
↓	Press "Down"
27.S2 threshold 92V 200ms	
↓	Press "Down"
27.S2: 227V 205ms	
↓	Press "Down"
81>.S1 threshold 50.5Hz 100ms	
↓	Press "Down"
81>.S1 49.9Hz 103ms	
↓	Press "Down"
81>.S2 threshold 51.5Hz 100ms	
↓	Press "Down"
81>.S2 49.9Hz 107ms	
↓	Press "Down"
81<.S1 threshold 49.5Hz 100ms	



2) Autotest STD

Select "2. Autotest STD", then press "OK" to start Auto test STD.

The test procedure is same as Autotest Fast, but it's much more time consuming.

3) PF Time Setting

Select "3. PF Time Setting", then press "OK". The following will be shown on the display:

Set: *. *** s

Press "Up" or "Down" to change the 1st digit, press "OK" to switch to next digit. After changing all digits, press "OK".

4) QV Time Setting

Select "4. QV Time Setting", then press "OK". The following will be shown on the display:

Set : ** s

Press "Up" or "Down" to change the 1st digit, press "OK" to switch to next digit. After changing all digits, press "OK".

5) Control 81.S1

Select "5. Control 81.S1", press "OK". Press "up" or "down" to select "Enable 81.S1" or "Disable 81.S1", press "OK".

6.4.2. Advanced setting

2.Advanced Setting	Input Password 0715
Up" ↑	1.Battery Parameter
	2.Clear Energy Data
	3.Clear Events
	4.Country
	5.Anti Reflux
"Down" ↓	6.IV Curve Scan
	7.Battery Active
	8.Logic interface Control
	9.Safety Param.

Select "2. Advanced Setting" and press "OK", "input password" is shown. Input the password "0001", press "Up" or "Down" to change the 1st digit, press "OK" to switch to next digit, when "0001" is shown on the screen, press "OK" to enter "2. Advanced Setting" interface.

If "Incorrect, Try Again!" is shown on the screen, press "Back" and input the password again.

1. Battery Parameter

1. Battery Parameter		
"Up" ↑	1) Battery Type	7) Max Discharge (A)
	2)* Battery Capacity	8)* Low (V) Protection
	3) Discharge Depth	9)* Min Discharge (V)
"Down" ↓	4) Max Charge (A)	10)* Empty Discharged (V)
	5)* Over (V) Protection	11)* Full Charged (V)
	6)* Max Charge (V)	12) Save

Note: 2)*, 5)*, 6)*, 8)*, 9)*, 10)* and 11)* settings are only for DEFAULT battery type.

1) Battery Type (refer to Set [battery type](#))

Select "1. Battery Type" and press "OK". Press "up" or "down" to select the battery type. Press "OK".

2) *Battery Capacity (only for DEFAULT battery type)

Select "2. Battery Capacity" and press "OK". Press "up" or "down" to change the 1st digit, press "ok" to switch to next digit. Input the value of battery capacity. Press "OK".

3) Discharge Depth

Select "3. Discharge Depth" and press "OK" to enter discharge depth interface.

Discharge Depth	50%
EPS Discharge Depth	80%
EPS Restore Depth	20%

Press "up" or "down" to change the 1st digit, press "ok" to switch to next digit. Input the value of Discharge Depth & EPS Discharge Depth per battery specification. Press "OK".

For example: if Discharge Depth = 50% & EPS Discharge Depth = 80%.

While grid is connected: HYD-ES inverter won't discharge the battery when its SOC is less than 50%.

In case of blackout: HYD-ES inverter will work in EPS mode (if EPS mode is enabled) & keep discharging the battery till battery SOC is less than 20%.

4) Max. Charge (A)

Select "4. Max. Charge (A)" and press "OK". Press "up" or "down" to change the 1st digit, press "ok" to switch to next digit. Input the value of Max. Charge (A) per battery specification. Press "OK".

5) *Over (V) Protection (only for DEFAULT battery type)

Select "5. Over (V) Protection" and press "OK". Press "up" or "down" to change the 1st digit, press "ok" to switch to next digit. Input the value of Over (V) Protection per battery specification. Press "OK".

6) *Max. Charge (V) (only for DEFAULT battery type)

Select "6. Max. Charge (V)" and press "OK". Press "up" or "down" to change the 1st digit, press "ok" to switch to next digit. Input the value of Max. Charge (V) per battery specification. Press "OK".

7) Max. Discharge (A)

Select "7. Max. Discharge (A)" and press "OK". Press "up" or "down" to change the 1st digit, press "ok" to switch to next digit. Input the value of Max. Discharge (A) per battery specification. Press "OK".

8) *Low (V) Protection (only for DEFAULT battery type)

Select "8. Low (V) Protection" and press "OK". Press "up" or "down" to change the 1st digit, press "ok" to switch

to next digit. Input the value of Low (V) Protection per battery specification. Press “OK”.

9) *Min. Discharge (V) (only for DEFAULT battery type)

Select “9. Min. Discharge (V)” and press “OK”. Press “up” or “down” to change the 1st digit, press “ok” to switch to next digit. Input the value of Min. Discharge (V) per battery specification. Press “OK”.

10) * Empty Discharged (V) (only for DEFAULT battery type)

Select “10. Empty Discharged (V)” and press “OK”. Press “up” or “down” to change the 1st digit, press “ok” to switch to next digit. Input the value of Empty Discharged Voltage per battery specification. Press “OK”.

11) * Full Charged (V) (only for DEFAULT battery type)

Select “11. Full Charged (V)” and press “OK”. Press “up” or “down” to change the 1st digit, press “ok” to switch to next digit. Input the value of Full Charged Voltage per battery specification. Press “OK”.

12) Save

Select “12. Save” and press “OK” to complete setting battery parameters.

2. Clear Energy Data

Select “2. Clear Energy” and press “OK”, “input password” is shown. Input the password “0001”, press “Up” or “Down” to change the 1st digit, press “OK” to switch to next digit, when “0001” is shown on the screen, press “OK”. If “Incorrect, Try Again!” is shown on the screen, press “Back” and input the password again.

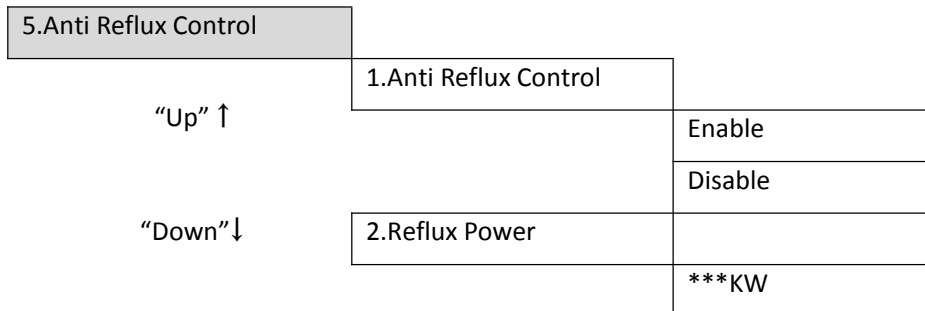
3. Clear Events

Select “3. Clear Events”, press “OK” button twice to clear all the events.

4. Country (refer to Set country)

Select “4. Country”, press “OK”, current country setting is shown, input new country code & press “OK”

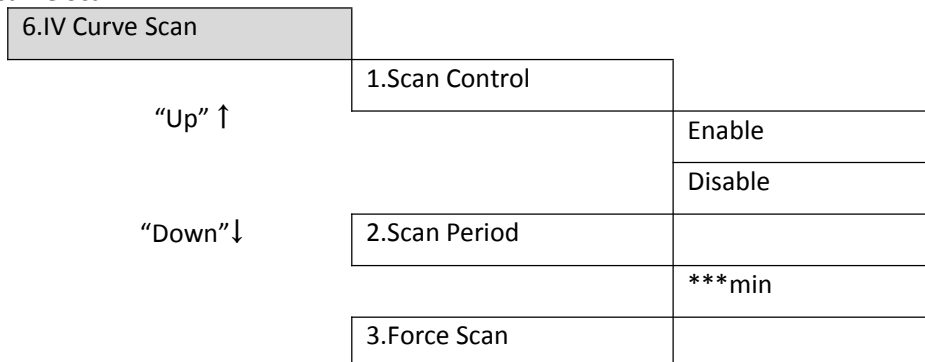
5. Anti Reflux



The user can enable “Anti Reflux Control” to limit the max export power to grid.

Select “2. Reflux Power” to input desired max export power to grid.

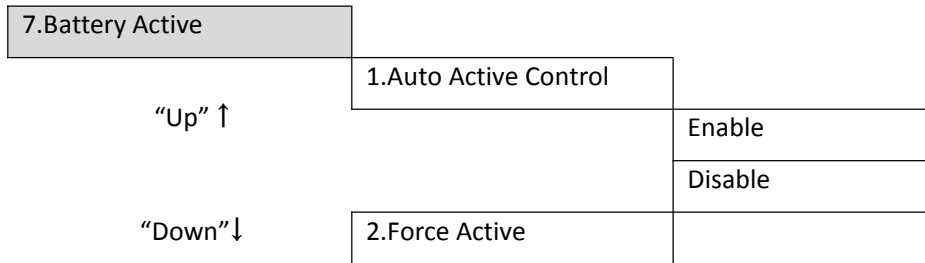
6. IV Curve Scan



The user can enable “IV Curve Scan” (MPPT scan) to make HYD-ES inverter to find the global max power point periodically to deliver max power from a partially shaded PV array.

The user can input scan period or make HYD-ES inverter to perform a scan right away.

7. Battery Active



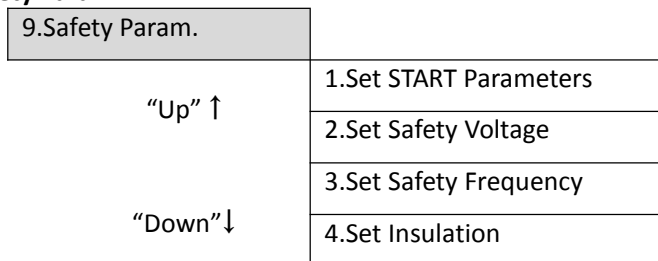
HYD-ES inverter can activate flat batteries when needed.

The user can enable "Auto Active Control" to allow HYD-ES inverter to activate flat batteries automatically. Or make HYD-ES inverter to activate the battery right away.

8. Logic interface control

Select "8. Logic interface Control", press "OK", press "up" or "down" to select "Enable Logic interface" or "Disable Logic interface", press "OK".

9. Safety Param.

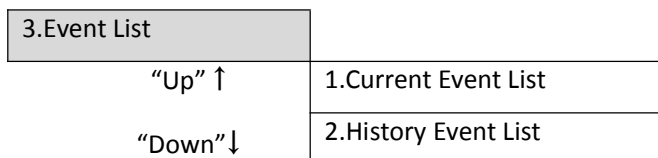


Copy the TXT file to the root directory of SD card.

Select "9. Safety Param.", press "OK", press "up" or "down" to select "1. Set START Parameters", "2. Set Safety Voltage", "3. Set Safety Frequency" or "4.Set Insulation", then press "OK".

Please contact SOFAR technical support for more information.

6.4.3. Event List



Event list of HYD-ES inverter, including current event list and history event list.

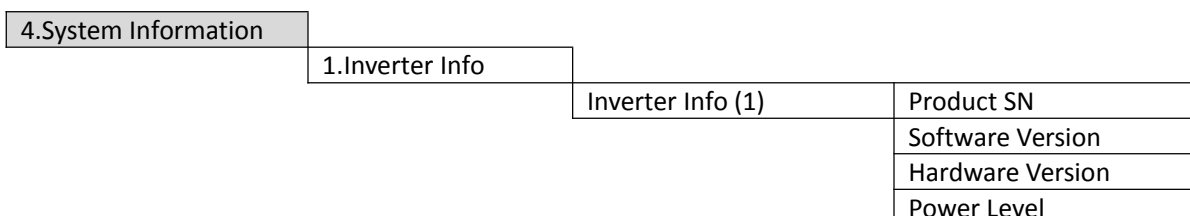
1) Current Event List

Select "1. Current Event List", press "OK" to check the current events.

2) History Event List

Select "2. History Event List", press "OK" to check the historical events. Press "up" or "down" to check all historical events if there're more than 1 page of events.

6.4.4. System information interface



"Up" ↑	Inverter Info(2)	Country	
		PV Input Mode	
		Energy Storage Mode	
	Inverter Info (3)	RS485 Address	
		EPS Mode	
		IV Curve Scan	
	Inverter Info (4)	Anti Reflux	
		DRMS Control	
		PF Time Setting	
		QV Time Setting	
	"Down" ↓	2.Battery Info	Power Factor
			Battery info (0)
Battery Capacity			
Discharge Depth			
Max Charge (A)			
Battery Info (1)		Over (V) Protection	
		Max Charge (V)	
		Max Discharge (A)	
		Min Discharge (V)	
3.Safety Param.		Safety Param.(0)	OVP 1
			OVP 2
			UVP 1
	UVP 2		
	Safety Param.(1)	OFF 1	
		OFF 2	
		UFP 1	
		UFP 2	
	Safety Param.(2)	OVP 10mins	

6.4.5. Energy Statistic

"Up" ↑	"Down" ↓	5.Energy Statistic	Today	
			PV	***KWH
			Load	***KWH
			Export	***KWH
			Import	***KWH
			Charge	***KWH
			Discharge	***KWH
			Week	
			PV	***KWH
			Load	***KWH
			Export	***KWH
			Import	***KWH
			Charge	***KWH
			Discharge	***KWH
			Month	
			PV	***KWH
			Load	***KWH

	Export	***KWH
	Import	***KWH
	Charge	***KWH
	Discharge	***KWH
	Year	
“Up”↑	PV	***KWH
	Load	***KWH
	Export	***KWH
	Import	***KWH
	Charge	***KWH
	Discharge	***KWH
	Lifetime	
“Down”↓	PV	***KWH
	Load	***KWH
	Export	***KWH
	Import	***KWH
	Charge	***KWH
	Discharge	***KWH
	Charge	***KWH
	Discharge	***KWH

Select “5. Energy Statistic”, press “OK” to enter Energy Statistic interface, it shows the energy generation and consumption within a certain range of time. Press “Up” or “Down” to check the daily / weekly / monthly / yearly / lifetime energy statistics.

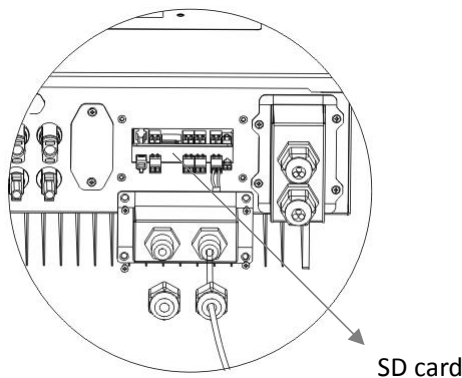
6.4.6. Software upgrade

Copy the firmware folder to the root directory of SD card.

Select “6. Software Update”, press “OK”, “input password” is shown. Input the password (“0715”), press “Up” or “Down” to change the 1st digit, press “OK” to switch to next digit, when “0715” is shown on the screen, press “OK”. HYD-ES inverter will start to upgrade the software automatically.

Detailed Firmware Upgrade Procedure:

Step 1 Turn OFF AC circuit breaker (grid & load), then turn OFF DC isolator (battery) and PV switch, then remove communication waterproof cover. If communication cables (CAN/RS485/NTC/CT) have been connected, loosen their cable glands before removing cover.



Step 2 Press the SD card and take it out. Insert the SD card into a micro-SD card reader, then insert micro-SD card reader into a PC; (NOTE: micro-SD card reader & PC are not provided by SOFARSOLAR).

Step 3 Format the SD card. Copy the “firmware” folder to the SD card.

Step 4 Insert the SD card back to the SD card slot.

Step 5 Turn ON AC circuit breaker (grid), press “Back” to enter main menu. Press “Down” to select “6. Software Update”, then press “Ok”.

Step 6 “input password” is shown. Input the password (“0715”), press “Up” or “Down” to change the 1st digit, press “OK” to switch to next digit, when “0715” is shown on the screen, press “Ok” to start firmware update.

Step 7 After finishing firmware upgrade, turn OFF AC circuit breaker (grid), lock the communication waterproof cover with four screws, then turn ON AC circuit breaker (grid), turn ON DC isolator (battery), turn on PV switch, HYD-ES inverter will start to operate automatically.

NOTE: If “DSP communicate fail”, “Update DSP1 Fail” or “Update DSP2 Fail” is shown on the screen, which means the firmware upgrade is unsuccessful, please turn OFF AC circuit breaker (grid), wait 5 minutes, then start again from “**Step 5**”

7. Troubleshooting

This section contains information and procedures for solving possible problems with the inverter.

- This section help users to identify the inverter fault. Please read the following procedures carefully:
- ✧ Check the warning, fault messages or fault codes shown on the inverter screen, record all the fault information.
- ✧ If there is no fault information shown on the screen, check whether the following requirements are met:
 - Is the inverter mounted in a clean, dry place with good ventilation?
 - Is the DC switch turned ON?
 - Are the cables adequately sized and short enough?
 - Are the input and output connections and wiring in good condition?
 - Are the configuration settings correct for the particular installation?
 - Are the display panel and the communication cables properly connected and undamaged?
- Follow the steps below to view recorded problems: Press "Back" to enter the main menu in the normal interface. In the interface screen select "Event List", then press "OK" to enter events.
- Earth Fault Alarm

This inverter complies with IEC 62109-2 clause 13.9 for earth fault alarm monitoring.

If an Earth Fault Alarm occurs, the fault will be displayed on the LCD screen, the red light will be on, and the fault can be found in the history of the fault. For the machine installed with WiFi/GPRS, the alarm information can be seen on the corresponding monitoring website, and can also be received by the APP on the mobile phone.

- EventList information

Table 7-1 Eventlist

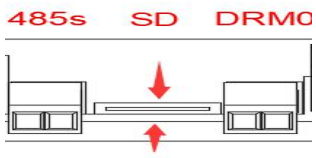
Code	Name	Description	Solution
ID01	GridOVP	The grid voltage is too high	If the alarm occurs occasionally, the possible cause is that the electric grid is abnormal occasionally. HYD-ES inverter will automatically return to normal operating status when the electric grid's back to normal.
ID02	GridUVP	The grid voltage is too low	
ID03	GridOFP	The grid frequency is too high	
ID04	GridUFP	The grid frequency is too low	If the alarm occurs frequently, check whether the grid voltage/frequency is within the acceptable range. If yes, please check the AC circuit breaker and AC wiring of the HYD-ES inverter. If the grid voltage/frequency is NOT within the acceptable range and AC wiring is correct, but the alarm occurs repeatedly, contact SOFAR technical support to change the grid over-voltage, under-voltage, over-frequency, under-frequency protection points after obtaining approval from the local electrical grid operator.
ID05	BatOVP	The battery voltage is too	If the alarm occurs occasionally, wait a while to see

		high	<p>if the problem is solved.</p> <p>If the alarm occurs frequently, check whether the battery overvoltage setting is inconsistent with the battery specification.</p>
ID06	OVRT fault	OVRT function is faulty	Check whether the grid voltage fluctuates greatly.
ID07	LVRT fault	LVRT function is faulty	
ID08	PVOVP	The PV voltage is too high	Check whether too many PV modules are series connected in a PV string, thus the PV string voltage (Voc) is higher than the maximum input voltage of HYD-ES inverter. If yes, adjust the number of series connected PV modules to decrease the PV string voltage to fit the input voltage range of HYD-ES inverter. HYD-ES inverter will automatically return to normal status after correcting adjustments
ID09	HW_LLCCBus_OVP	LLCCBus voltage is too high and has triggered hardware protection	<p>ID09- ID12 are internal faults of HYD-ES inverter, switch OFF HYD-ES inverter, wait for 5 minutes, then switch ON HYD-ES inverter. Check whether the problem is solved.</p> <p>If no, please contact SOFAR technical support.</p>
ID10	HW_Boost_OVP	Boost voltage is too high and has triggered hardware protection	
ID11	HwBuckBoostOCP	BuckBoost current is too high and has triggered hardware protection	
ID12	HwBatOCP	The battery current is too high and has triggered hardware protection	
ID13	GFCI OCP	The GFCI sampling value between the master DSP and slave DSP is not consistent	<p>If the fault occurs occasionally, the possible cause is that the external circuits are abnormal occasionally. HYD-ES inverter automatically returns to normal operating status after the fault is rectified.</p> <p>If the fault occurs frequently and lasts a long time, check whether the insulation resistance between the PV array and earth(ground) is too low, also check the insulation conditions of PV cables.</p>
ID14	HWPVOCP	The PV current is too high and has triggered hardware protection	<p>ID14-ID15 are internal faults of HYD-ES inverter, switch OFF HYD-ES inverter, wait for 5 minutes, then switch ON HYD-ES inverter. Check whether the problem is solved.</p> <p>If no, please contact SOFAR technical support.</p>
ID15	HwAcOCP	The grid current is too high and has triggered hardware protection	
ID16	IpvUnbalance	Input current is not balanced	Check the PV input mode (parallel mode/independent mode) setting of HYD-ES inverter. If it's incorrect, change the PV input mode .
ID17	HwADFaultIGrid	The grid current sampling error	ID17-ID26 are internal faults of HYD-ES inverter, switch OFF HYD-ES inverter, wait for 5 minutes,

ID18	HwADFaultDCI	The DCI sampling error	then switch ON HYD-ES inverter. Check whether the problem is solved. If no, please contact SOFAR technical support.	
ID19	HwADFaultVGrid	The grid voltage sampling error		
ID20	GFCIDeviceFault	The GFCI sampling error		
ID21	MChip_Fault	The master chip fault		
ID22	HwAuxPowerFault	The auxiliary voltage error		
ID25	LLCBusOVP	LLCBus voltage is too high		
ID26	SwBusOVP	Bus voltage is too high and has triggered software protection	If the fault occurs frequently, please contact SOFAR technical support.	
ID27	BatOCP	Battery current is too high		
ID28	DciOCP	The DCI is too high		ID28-ID31 are internal faults of HYD-ES inverter, switch OFF HYD-ES inverter, wait for 5 minutes, then switch ON HYD-ES inverter. Check whether the problem is solved. If no, please contact SOFAR technical support.
ID29	SwOCPInstant	The grid current is too high		
ID30	BuckOCP	Buck current is too high		
ID31	AcRmsOCP	The output current is too high		
ID32	SwBOCPInstant	The input current is too high	Check whether the input current is higher than the maximum input current of HYD-ES inverter, then check the input wiring, if both are correct, please contact technical support.	
ID33	PvConfigSetWrong	Incorrect input mode	Check the PV input mode (parallel mode/independent mode) setting of HYD-ES inverter. If it's incorrect, change the PV input mode .	
ID34	Overload	The load is overloaded	Check if the load power is out of range, and if so, adjust the power to the correct range.	
ID35	CT Fault	The CT is fault	Check whether the CT connection is firm and the installation direction is correct.	
ID48	ConsistenFault	The GFCI sampling value between the master DSP and slave DSP is not consistent	ID48-ID51 are internal faults of HYD-ES inverter, switch OFF HYD-ES inverter, wait for 5 minutes, then switch ON HYD-ES inverter. Check whether the problem is solved. If no, please contact SOFAR technical support.	
ID49	ConsistentFault_Vgrid	The grid voltage sampling value between the master DSP and slave DSP is not consistent		
ID50	ConsistentFault_Fgrid	The grid frequency sampling value between the master DSP and slave DSP is not consistent		
ID51	ConsistentFault_DCI	The Dci sampling value between the master DSP and slave DSP is not		

		consistent	
ID52	BatCommunication Flag	HYD-ES inverter can't communicate with Lithium battery BMS correctly.	<p>Make sure the battery you're using is compatible with HYD-ES inverter.</p> <p>Make sure you've selected the correct battery type. Check the communication cable between battery & HYD-ES inverter.</p> <p>It's recommended to use CAN communication.</p> <p>For PYLONTECH US2000 PLUS battery, and you're using RS485 communication, the ADD DIP switch should be all down.</p>
ID53	SpiCommLose	SPI communication is fault	<p>ID53-ID55 are internal faults of HYD-ES inverter, switch OFF HYD-ES inverter, wait for 5 minutes, then switch ON HYD-ES inverter. Check whether the problem is solved.</p> <p>If no, please contact SOFAR technical support.</p>
ID54	SciCommLose	SCI communication is fault	
ID55	RecoverRelayFail	The relays fault	
ID56	PvIsoFault	The insulation resistance is too low	<p>Check the insulation resistance between the PV array and earth(ground), if a short circuit occurs, rectify the fault.</p>
ID57	OverTempFault_BAT	The battery temp is too high	<p>Please make sure HYD-ES inverter is installed in a place without direct sunlight.</p>
ID58	OverTempFault_HeatSink	The temperature of heat sink is too high	<p>Please make sure HYD-ES inverter is installed in a cool / well-ventilated place.</p>
ID59	OverTempFault_Env	The environment temperature is too high	<p>Make sure the inverter is vertically installed & the ambient temperature is less than the temperature upper limit of HYD-ES inverter</p>
ID60	PE connectFault	Grounding not correct	<p>Check the grounding of AC output PE wire.</p>
ID65	unrecoverHwAcOCP	The grid current is too high and has cause unrecoverable hardware fault	<p>ID65-ID67 are internal faults of HYD-ES inverter, switch OFF HYD-ES inverter, wait for 5 minutes, then switch ON HYD-ES inverter. Check whether the problem is solved.</p> <p>If no, please contact SOFAR technical support.</p>
ID66	unrecoverBusOVP	The bus voltage is too high and has cause unrecoverable fault	
ID67	BitEPSunrecover BatOcP	Unrecoverable fault of battery overcurrent in EPS mode	
ID68	UnrecoverIpv Unbalance	The input current is unbalance, and has triggered unrecoverable fault	<p>Check the PV input mode (parallel mode/independent mode) setting of HYD-ES inverter. If it's incorrect, change the PV input mode.</p>
ID70	UnrecoverOCPIstant	The grid current is too high, and has cause unrecoverable fault	<p>Internal faults of HYD-ES inverter, switch OFF HYD-ES inverter, wait for 5 minutes, then switch ON HYD-ES inverter. Check whether the problem is solved.</p> <p>If no, please contact SOFAR technical support.</p>

ID73	UnrecoverIPVConfigSetWrong	Input mode is uncorrectly set	Check the PV input mode (parallel mode/ independent mode) setting of HYD-ES inverter. If it's incorrect, change the PV input mode .
ID74	UnrecoverPvInatant	Input current is too high this caused unrecoverable hardware fault	Internal faults of HYD-ES inverter, switch OFF HYD-ES inverter, wait for 5 minutes, then switch ON HYD-ES inverter. Check whether the problem is solved. If no, please contact SOFAR technical support.
ID75	UnrecoverWRITE EEPROM	Unrecoverable EEPROM write	ID75-ID77 are internal faults of HYD-ES inverter, switch OFF HYD-ES inverter, wait for 5 minutes, then switch ON HYD-ES inverter. Check whether the problem is solved. If no, please contact SOFAR technical support.
ID76	UnrecoverREDEEPROM	Unrecoverable EEPROM read	
ID77	UnrecoverRelayFail	Relay has triggered permanent fault	
ID81	Over TempDerating	Internal temperature is too high.	Please make sure HYD-ES inverter is installed in a place without direct sunlight. Please make sure HYD-ES inverter is installed in a cool / well-ventilated place. Make sure the inverter is vertically installed & the ambient temperature is less than the temperature upper limit of HYD-ES inverter.
ID82	Over FreqDerating	AC frequency is too high	Please make sure the grid frequency is within the acceptable range.
ID83	RemoteDerating	Remote power derate	HYD-ES inverter receives a remote signal to decrease its power.
ID84	Remote Off	Switch OFF HYD series inverter remotely	HYD-ES inverter receives a remote signal to switch OFF.
ID85	SOC <= 1 -DOD or Battery undervoltage	Battery voltage below SOC	For example, if you set DOD to 30%, when SOC is less than 70%, you will see ID85 in the event list. HYD-ES inverter won't discharge the battery when ID85 is present. Or this is an indication of low battery voltage. HYD-ES inverter won't discharge battery in this case to ensure long battery cycle life.
ID86	Force charge failure	Force charge failure	Check whether PV and grid conditions meet charging conditions.
ID94	Software version is not consistent	Software version between control board and com board is not consistent	Contact SOFAR technical support to upgrade software.
ID95	Communication board EEPROMFault	The Communication board EEPROM is faulty	ID95-ID96 are internal faults of HYD-ES inverter, switch OFF HYD-ES inverter, wait for 5 minutes, then switch ON HYD-ES inverter. Check whether the problem is solved. If no, please contact SOFAR technical support.
ID96	RTC clock chip anomaly	RTC clock chip is faulty	

ID98	Sdfault	The SD card is faulty	<p>Normally ID98 is caused by loose SD card holder. Click & take out SD card, press SD card holder then insert SD card back can normally solve this problem.</p> 
ID99	Wifi fault	The Wifi is error	Just for alarm in factory.
ID100	BatOCD	Battery over current discharging protect	<p>ID100-ID103 is battery fault. If this fault occurs occasionally, wait a few minutes to see whether the problem is solved.</p> <p>If this fault occurs frequently, please contact SOFAR technical support.</p>
ID101	BatSCD	Discharging short circuit protect	
ID102	BatOVP	Battery Overvoltage protect	
ID103	BatUV	Battery low voltage protect	
ID104	BatOTD	Battery high temperature protect while discharging	<p>Make sure battery is in a well-ventilated place.</p> <p>Try to decrease the max discharge (A) or/and max charge (A) to see if the problem is solved.</p>
ID105	BatOTC	Battery high temperature protect while charging	
ID106	BatUTD	Battery low temperature protect while discharging	<p>Try to increase the ambient temperature of the battery.</p>
ID107	BatUTC	Battery low temperature protect while charging	

Maintenance

Inverters generally do not need any daily or routine maintenance. Heat sink should not be blocked by dust, dirt or any other items. Before the cleaning, make sure that the DC SWITCH is turned OFF and the circuit breaker between inverter and electrical grid is turned OFF. Wait at least for 5 minutes before the Cleaning.

✧ Inverter cleaning

Please clean the inverter with an air blower, a dry & soft cloth or a soft bristle brush. Do NOT clean the inverter with water, corrosive chemicals, detergent, etc.

✧ Heat sink cleaning

For the long-term proper operation of inverters, ensure there is enough space around the heat sink for ventilation, check the heat sink for blockage (dust, snow, etc.) and clean them if they exist. Please clean the heat sink with an air blower, a dry & soft cloth or a soft bristle brush. Do NOT clean the heat sink with water, corrosive chemicals, detergent, etc.

8. Technical Data

Model	HYD 3000-ES	HYD 3600-ES	HYD 4000-ES	HYD * 4600-ES	HYD 5000-ES	HYD 6000-ES
Battery Parameters						
Battery Type	Lead-acid, Lithium-ion					
Nominal battery voltage	48V					
Battery voltage range	42 - 58V					
Min discharge voltage	Lithium:(according to BMS), General 46.0V					
	Lead acid: 44.0V					
Max charge voltage	Lithium-ion:(according to BMS), Max 58V					
	Lead acid: 58V					
Battery capacity	50-2000Ah					
Recommended storage capacity	9.6 kWh					
Max charge current	65A					
Charge current range	0 – 65A programmable					
Charge curve	3 - stage adaptive with maintenance					
Max discharge current	70A programmable					
Battery protection	Over voltage protection / Over current protection / Over temperature protection					
Depth of discharge	Lithium: 0 – 90% DOD adjustable					
	Lead acid: 0 – 50% DOD adjustable					
PV parameters						
Recommended Max.PV input power	3990Wp	4790Wp	5320Wp	6120Wp	6650Wp	7980Wp
Max DC input power	3500W	4000W	4400W	5000W	5500W	6600W
Max DC power for single MPPT	2000W (160V-520V)	2400W (180V-520V)	2600W (200V-520V)	2800W (230V-520V)	3000W (250V-520V)	3500W (300V-520V)
The max DC input voltage	600V					
Start-up DC voltage	120V					
Nominal DC Voltage	360V					
MPPT operating voltage range	90-580V					
Full load DC voltage range	160V-520V	180V-520V	200V-520V	230-520V	250V-520V	300V-520V

MPPT number	2					
The max DC input current	12A/12A					
The max DC input short current	15A/15A					
AC parameters						
Max output power	3000W	3680W	4000W	4600W	5000W	6000W
Max output current	13.7A	16A	18.2A	21.0A	22.8A	27.3A
Nominal grid voltage & frequency	220V,230V,240V, 44 – 55Hz or 54 – 66Hz					
AC voltage range	180 – 276V (according to local authority requirements)					
THD	<3%					
Power factor	1default (+ / - 0.8 adjustable)					
Inrush current	0.8A / 1us					
Max output fault current	100A / 1us					
System parameters						
Max efficiency	Charge: 94.6% / discharge 94.6%					
Standby losses	< 10W (PV SPS)					
Topology	High frequency isolation(for bat)					
Ingress protection ratings	IP 65					
Safety protection	Anti-islanding, RCMU, ground fault monitoring					
Communication	Wi-Fi/GPRS/Ethernet(optional), RS485, SD,CAN2.0					
Certification	EN 61000-6-2, EN 61000-6-3, EN 61000-3-2, EN 61000-3-3, EN 61000-3-11, EN 61000-3-12 IEC62109-1/2, IEC62040-1, IEC62116, IEC61727, IEC-61683, IEC60068(1,2,14,30) AS/NZS 4777, VDE V 0124-100, V 0126-1-1, VDE-AR-N 4105, CEI 0-21, EN50438/EN50549, G83/G59/G98/G99, UTE C15-712-1, UNE 206 007-1					
Environmental data						
Ambient temperature range	-25°C to +60°C(Derating above +45°C)					
Relative humidity range	0% - 100% (no condensing)					
Protective class	Class I					
Max operating altitude	2000m					
Current transformer connection	Hard wired					

General data	
Noise	<25dB
Weight	20.5kg
Cooling	Natural convection
Dimensions (W*H*D)	566 x 394 x 173 mm
Display	LCD display
Warranty	5 years or more
EPS (Emergency Power Supply) data	
EPS rated power	3000VA
EPS nominal voltage/frequency	230V, 50/60Hz
EPS rated current	13.2A
THD	<3%
Switch time	10mS default

The models marked with “*” should be available only for some designated countries.

9. Quality Assurance

Standard warranty period

The standard warranty period of inverter is 60 months (5 years). There are two calculation methods for the warranty period:

1. Purchase invoice provided by the customer: the first flight provides a standard warranty period of 60 months (5 years) from the invoice date;
2. The customer fails to provide the invoice: from the production date (according to the SN number of the machine), Our company provides a warranty period of 63 months (5.25 years).
3. In case of any special warranty agreement, the purchase agreement shall prevail.

Extended warranty period

Within 12 months of the purchase of the inverter (based on the purchase invoice) or within 24 months of the production of the inverter(SN number of machine, based on the first date of arrival),Customers can apply to buy extended warranty products from the company's sales team by providing the product serial number, Our company may refuse to do not conform to the time limit extended warranty purchase application. Customers can buy an extended warranty of 5, 10, 15 years.

If the customer wants to apply for the extended warranty service, please contact the sales team of our company. to purchase the products that are beyond the purchase period of extended warranty but have not yet passed the standard quality warranty period. Customers shall bear different extended premium.

During the extended warranty period, pv components GPRS, WIFI and lightning protection devices are not included in the extended warranty period. If they fail during the extended warranty period, customers need to purchase and replace them from our company.

Once the extended warranty service is purchased, our company will issue the extended warranty card to the customer to confirm the extended warranty period.

Invalid warranty clause

Equipment failure caused by the following reasons is not covered by the warranty:

- 1) The "warranty card" has not been sent to the distributor or our company;
- 2) Without the consent of our company to change equipment or replace parts;
- 3) Use unqualified materials to support our company's products, resulting in product failure;
- 4) Technicians of non-company modify or attempt to repair and erase the product serial number or silk screen;
- 5) Incorrect installation, debugging and use methods;
- 6) Failure to comply with safety regulations (certification standards, etc.);
- 7) Damage caused by improper storage by dealers or end users;
- 8) Transportation damage (including scratches caused by internal packaging during transportation). Please claim directly from the transportation company or insurance company as soon as possible and obtain damage identification such as container/package unloading;
- 9) Failure to follow the product user manual, installation manual and maintenance guidelines;
- 10) Improper use or misuse of the device;
- 11) Poor ventilation of the device;
- 12) The product maintenance process does not follow relevant standards;

13) Failure or damage caused by natural disasters or other force majeure (such as earthquake, lightning strike, aware fire, etc.)

Statement

If you have purchased this product in Australia, you should be aware that this warranty is provided in addition to other rights and remedies held by a consumer at law.

Our goods come with guarantees that cannot be excluded under the Australian Consumer Law. You are entitled to a replacement or refund for a major failure and compensation for any other reasonably foreseeable loss or damage. You are also entitled to have the goods repaired or replaced if the goods fail to be of acceptable quality and the failure does not amount to a major failure.



Company Name: Shenzhen SOFARSOLAR Co., Ltd.
ADD: 401, Building 4, AnTongDa Industrial Park, District 68, XingDong Community,
XinAn Street, BaoAn District, Shenzhen, GuangDong.P.R. China
Email: service@sofarsolar.com
Tel: 0510-6690 2300
Web: www.sofarsolar.com