

## Anclaje de la fijación a la cubierta

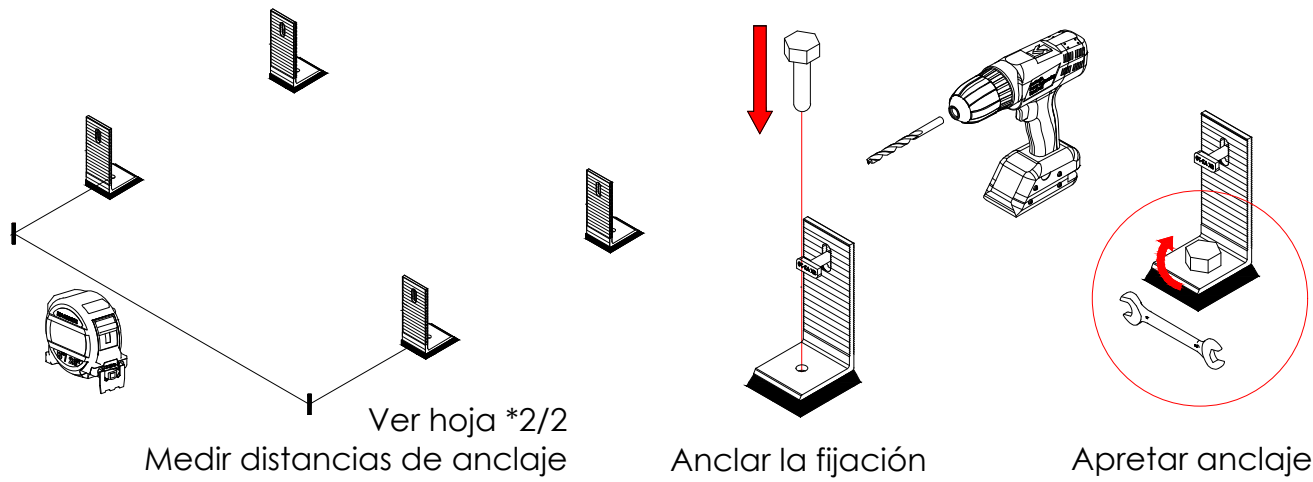

**Nota**  
Tornillería de anclaje no incluida. Válido para tornillos de hasta M8

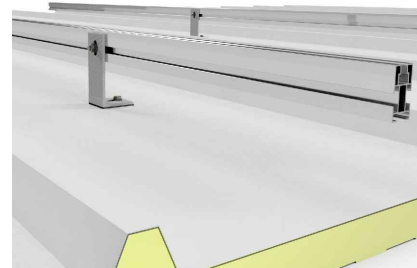
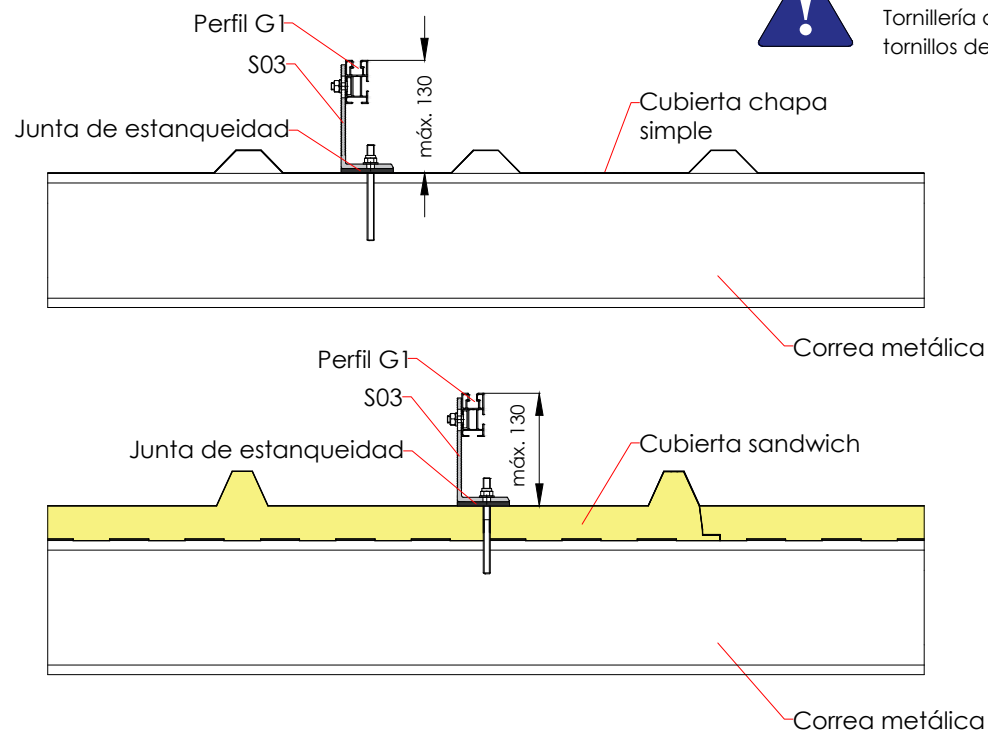

## Soporte coplanar continuo fijación a correas para cubierta metálica.

Horizontal. **03H**

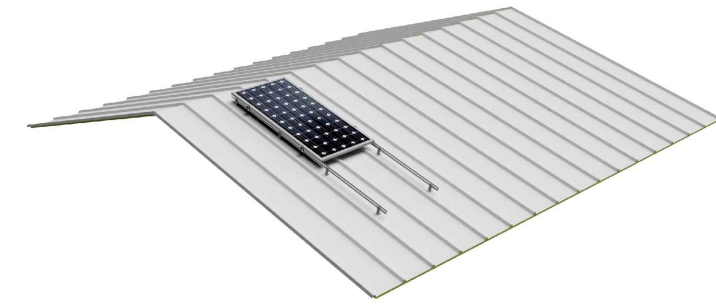

Perfiles perpendiculares a la cumbre

## Ubicar los módulos sobre los perfiles

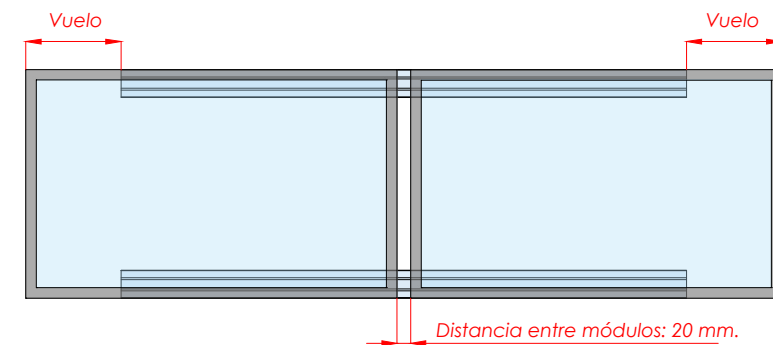

Distribuir los módulos para que su colocación sea simétrica a lo largo del soporte, dejando la misma distancia de sobrante en los extremos. Dejar una separación entre módulos de 20mm.

## Colocación de los los perfiles guía sobre las fijaciones y unión entre perfiles

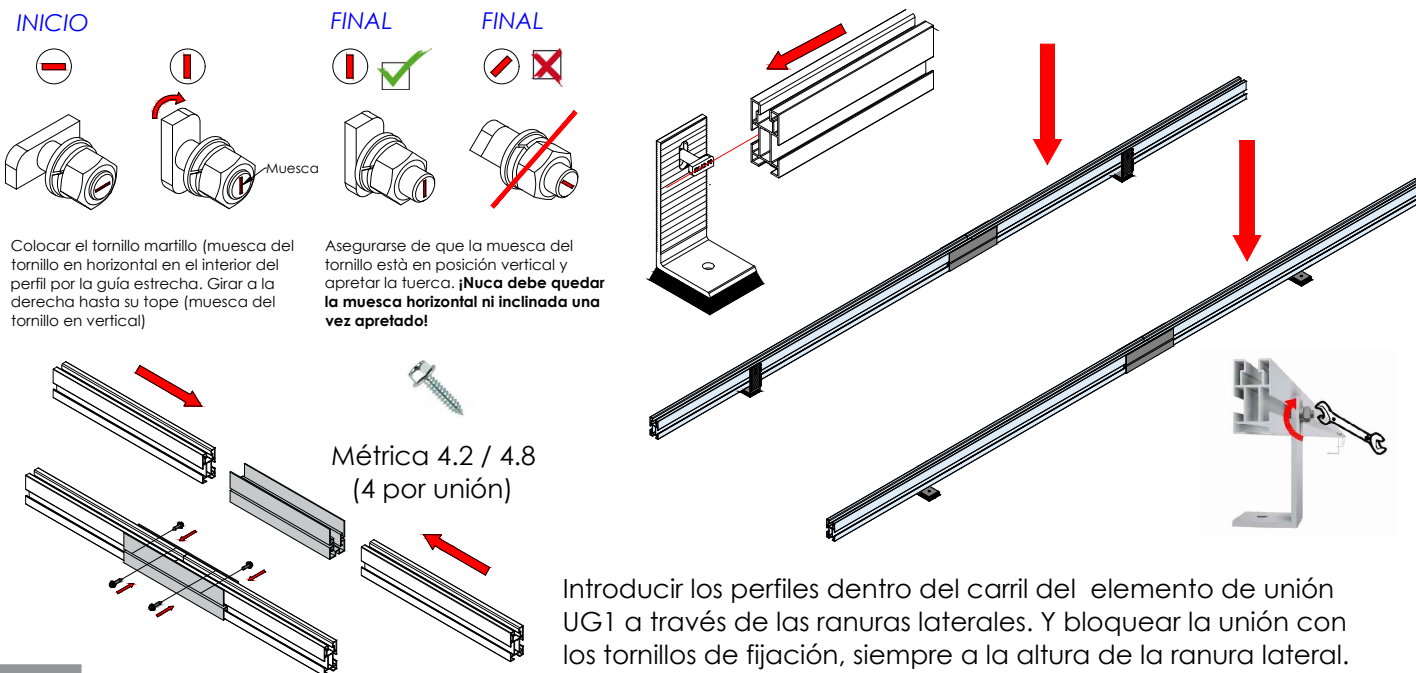

## Fijación de los módulos con los presores y colocación de las tapas G1

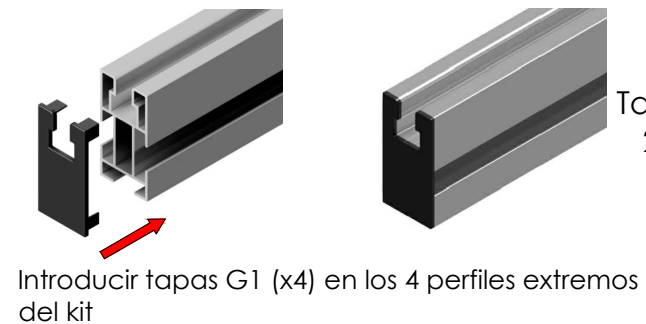
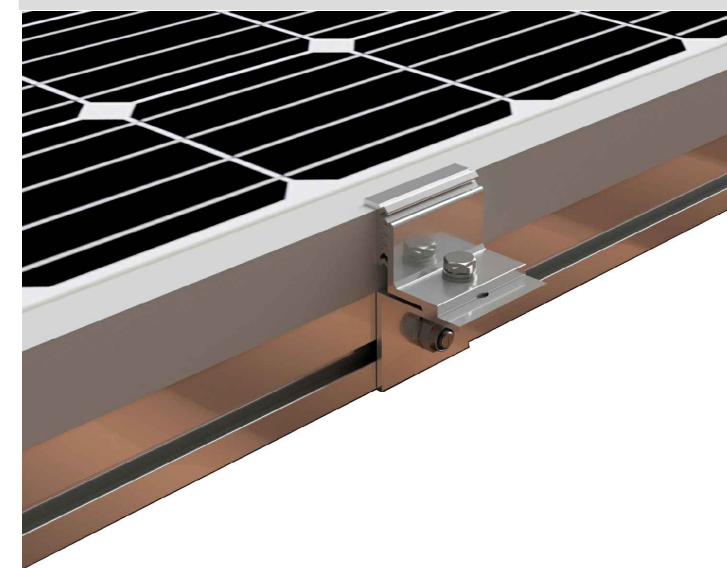

Tamaño máx.  
2279x1150

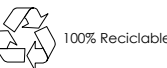
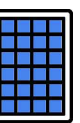

Marcado  
ES19/86524

**Nota:**



- Comprobar el buen estado de la cubierta y la capacidad portante de la misma
- Comprobar la impermeabilidad de la fijación una vez colocada

**Soporte coplanar continuo fijación a correas para cubierta metálica**

Horizontal

**03H**

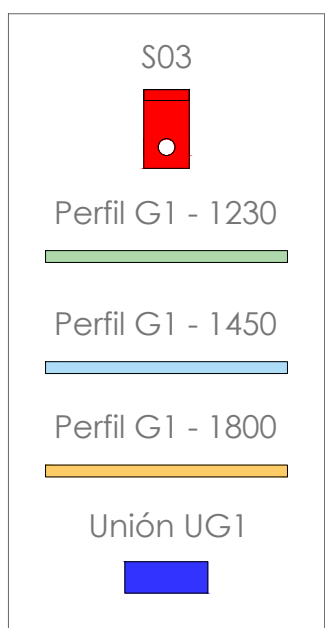

**Par de apriete:**

Tornillo Presor	7 Nm
Tornillo M8 Hexagonal	20 Nm
Tornillo M10 Hexagonal	40 Nm
Tornillo M4.2/4.8 Hexagonal	6 Nm



Ejemplos

Ancho módulo	1000	1048	1052	1150
Distancia L (mm)	1006	1054	1058	1156

1

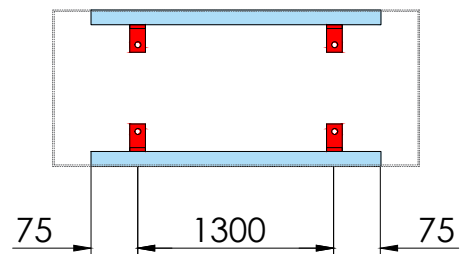

2

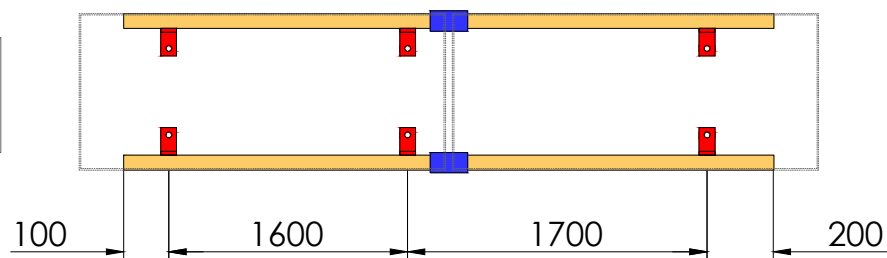

3

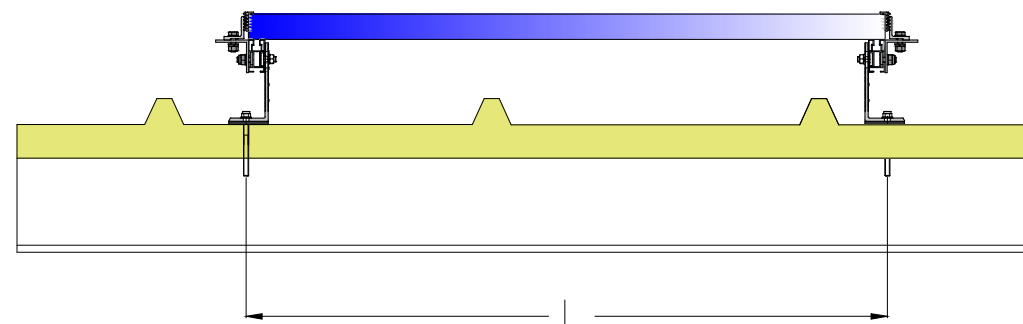
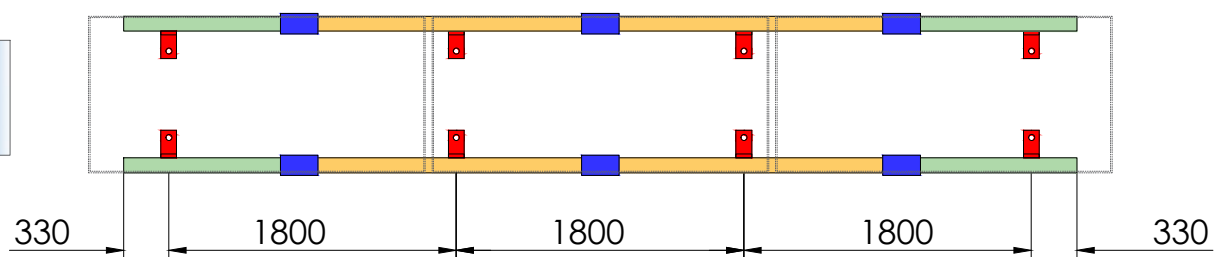

$L = (\text{Ancho del módulo}) + 6 \text{ mm}$

Revisar ficha técnica del módulo Tamaño máx. 2279x1150



03H1	4	4	-	-	2	-
03H2	6	8	2	-	-	4
03H3	8	12	6	4	-	4



CARACTERÍSTICAS DEL MONTAJE